



Transport Air Conditioning

*Carrier*

***FlexCLIK***<sup>®</sup>

58-64105-03 #12 [16MM], 35 Bar, SAE J2064 Type E

*Carrier*

***FlexCLIK***<sup>®</sup>

58-64105-02 #10 [13MM], 35 Bar, SAE J2064 Type E

*Carrier*

***FlexCLIK***<sup>®</sup>

58-64105-01 #8 [10MM], 35 Bar, SAE J2064 Type E

**SERVICE PARTS LIST  
AND  
ASSEMBLY INSTRUCTIONS  
for  
“FlexCLIK” Hose & Fittings**



**TRANSICOLD**

---

**SERVICE PARTS LIST  
TRANSPORT  
AIR CONDITIONING**

**“FlexCLIK” Hose, Fittings & Kits  
With  
Assembly Instructions**

## TABLE OF CONTENTS

1	INTRODUCTION .....	ii
2	ORDERING INSTRUCTIONS .....	ii
3	GENERAL NOTES .....	ii
<b>FlexCLIK ASSEMBLY TOOLS .....</b>		<b>1</b>
	FlexCLIK - ASSEMBLY TOOLS .....	2
<b>FlexCLIK HOSE-FITTING ASSEMBLY INSTRUCTIONS .....</b>		<b>3</b>
<b>FlexCLIK FITTINGS &amp; Quick-CLICK CROSS-REFERENCE .....</b>		<b>8</b>
	FlexCLIK FITTING PART NUMBER - KITTED .....	8
	FlexCLIK - CROSS REFERENCE - FlexCLIK & Quick-CLICK .....	9
<b>FlexCLIK FITTINGS .....</b>		<b>12</b>
	O-RING PILOT THREAD SIZES .....	12
	FITTING, 90 DEGREE FEMALE O-RING - LOW SIDE PORT .....	13
	FITTING, TEE .....	13
	FITTING, 90 DEGREE FEMALE O-RING - HIGH SIDE PORT .....	14
	FITTING, HOSE SPLICER, WITH 1/4 SCHRADER .....	14
	FITTING, "Y" .....	15
	FITTING, HOSE SPLICER .....	15
	FITTING, 45 DEGREE, MALE O-RING .....	16
	FITTING, 90 DEGREE SPLICER .....	16
	FITTING, 90 DEGREE, PILOT O-RING .....	17
	FITTING, 90 DEGREE, METRIC, MALE INSERT O-RING .....	17
	FITTING, METRIC, 90 DEGREE, FEMALE O-RING .....	18
	FITTING, GM BLOCK .....	18
	FITTING, 180 DEGREE, FEMALE O-RING .....	19
	FITTING, 90 DEGREE FEMALE FLARE TO FlexCLIK HOSE .....	19
	FITTING, STRAIGHT, FEMALE O-RING .....	20
	FITTING, 90 DEGREE FEMALE O-RING .....	20
	FITTING, 90 DEGREE MALE O-RING .....	21
	FITTING, STRAIGHT, MALE O-RING .....	21
	FITTING, STRAIGHT, MALE O-RING WITH HIGH SIDE ACCESS .....	22
	FITTING, STRAIGHT .....	22
	FITTING, STRAIGHT, MALE INSERT O-RING .....	23
	FITTING, 90 DEGREE FEMALE O-RING WITH 1/4 SCHRADER .....	23
	FITTING, 90 DEGREE FEMALE O-RING SEAL (SWIVEL) .....	24
	FITTING, SPLICER, WITH HIGH-SIDE ACCESS .....	24
	FITTING, 45 DEGREE, FEMALE O-RING .....	25
	FITTING, SPLICER, WITH LOW-SIDE ACCESS .....	25
<b>FlexCLIK HOSE - CLAMPS - CAGES &amp; O-RINGS .....</b>		<b>26</b>
	HOSE, FLEXCLIK .....	26
	O-RING, FlexCLIK .....	26
	FlexCLIK CLAMP KITS - CAGE & CLIPS .....	27

# INTRODUCTION

## 1 INTRODUCTION

This Manual identifies service replacement parts for Carrier Transport Air Conditioning FlexCLIK hose and fittings, along with Assembly Instructions.

Carrier FlexCLIK hose is color-coded for ease of identification of hose and fitting assemblies.

BLUE: #12 (16MM) and #16 (22MM) Hose

RED: #10 (13MM) Hose

GREEN: #8 (10MM) Hose

BLACK: #6 (8MM) Hose

## 2 ORDERING INSTRUCTIONS

All orders and inquiries for parts must include: Unit Part Number and description of part as shown on list and quantity required. Address all correspondence for parts to the following address or Fax number:

MAIL : CARRIER TRANSICOLD DIVISION  
Performance Parts Group, TR-20  
P.O. Box 4805  
Syracuse, NY 13221  
FAX: (315) 432-3778

## 3 GENERAL NOTES

To find replacement parts, determine major group in which replacement part is located. Consult table of contents for the appropriate page for the illustrated breakdown of the replacement part. The following letter designations are used to classify parts throughout this list.

**A/R** *As Required*

**NSA** *Not Stock Assembly* - Order components listed under the assembly.

**NSS** *Not Sold Separately* - Order next higher assembly or kit.

**P--** *Suffix P--* added to part number means part is available in packaged quantity only.

**PL** *Purchase Locally.*

**SST** *Stainless Steel* - 300 Series unless otherwise specified.

**SV** *Suffix SV* added to part number designates service replacement part.

**NS** *Not Shown* on illustration.



## CAUTION

Special care should be taken when selecting the proper refrigerant hose and fittings. The information contained in this manual is provided as a general guide to assist in making the appropriate product selection. This manual does not address every parameter that must be considered when selecting a product. The user must make the final product selection in consideration of the user's unique requirements.

Additionally, special care must be taken when working with refrigerant systems. Sudden escape of refrigerant gases may result in blindness or severe injury. Carrier Transicold recommends adherence to the guidelines and general practices as defined in SAE J2211 for the service and containment of HFC-134a, as well as all applicable EPA guidelines and procedures concerning the service of refrigerant systems.



## WARNING

Failure to follow these assembly instructions and/or the use of Carrier FlexCLIK hose with fittings supplied by other manufacturers may result in unreliable and unsafe hose assemblies, which may result in sudden or unintended release of refrigerant gases. Personal injury and/or violations of EPA regulations may occur as a consequence.

**SECTION 1**  
**FlexCLIK ASSEMBLY TOOLS**



Part Number	Description
07-00507-00	Carrier FlexCLIK System Installation Kit

**FlexCLIK - ASSEMBLY TOOLS**



Part Number	Description
07-00508-00	Ratching Connecting Tool for #16 Hose
07-00467-00	Connecting Tool (Pliers)
AC101-708	Hose Cutter Tool
AC101-711	Hose Cutter Replacement Blade

## SECTION 2

### FlexCLIK HOSE-FITTING ASSEMBLY INSTRUCTIONS

The FlexCLIK System is designed for assembly with FlexCLIK multi-refrigerant hose. Its engineered connection exceeds SAE J2064 and has been vibration and impulse tested. The benefits of FlexCLIK are virtually endless:

- No Guess Work
- No leaking Crimps
- No power supply needed
- As easy to use as a pair of pliers
- Easy to use in confined areas

FlexCLIK System Components Are Simple To Identify, Order And Use.

#### CHECKLIST

- Pliers (07-00467-00)
- Cutting Tool (AC101-708)
- Refrigerant oil compatible with refrigeration or A/C system
- FlexCLIK Refrigerant Hose
- FlexCLIK Fitting assembly
- Appropriately sized clips and cage

**NOTE:** The two black O-Rings on the FlexCLIK fitting assemblies are of a specific rubber compound and size. They should NOT be removed or replaced.

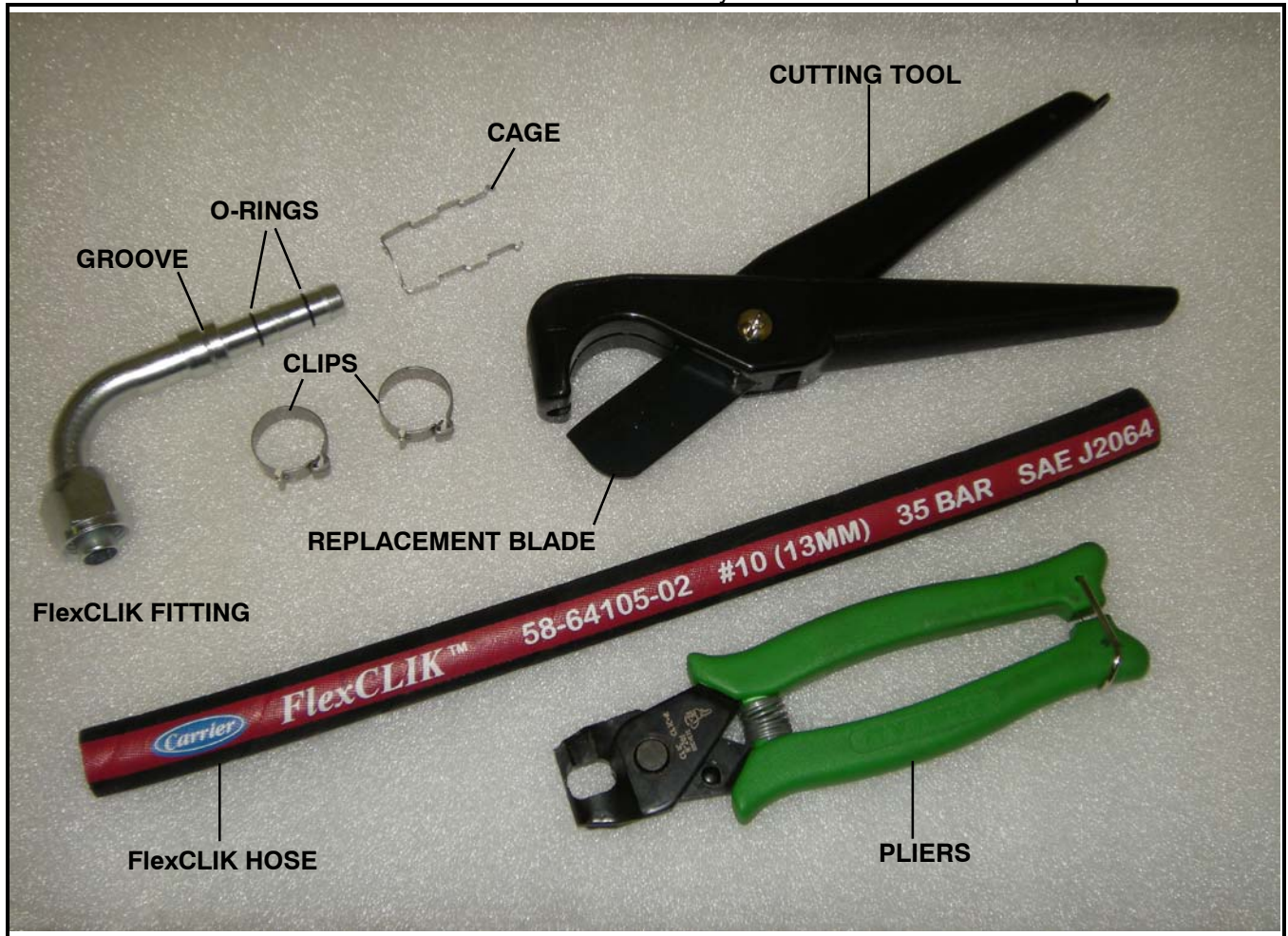



### Step 1: Cut the Hose

Cut the hose to proper length with an appropriate cutting tool.

Be sure the cut is made square to the hose length.



### Step 2: Slide on Two Clips

Install two proper-sized clips onto the cut end of the hose.

Orientation of the clips does not affect the performance of the connection. However, for ease of assembly, both clips should have the same orientation.

**Note:** Failure to slide the clips over the hose at this time will require the clips to be stretched over the hose or fitting later, which may permanently damage the clip.

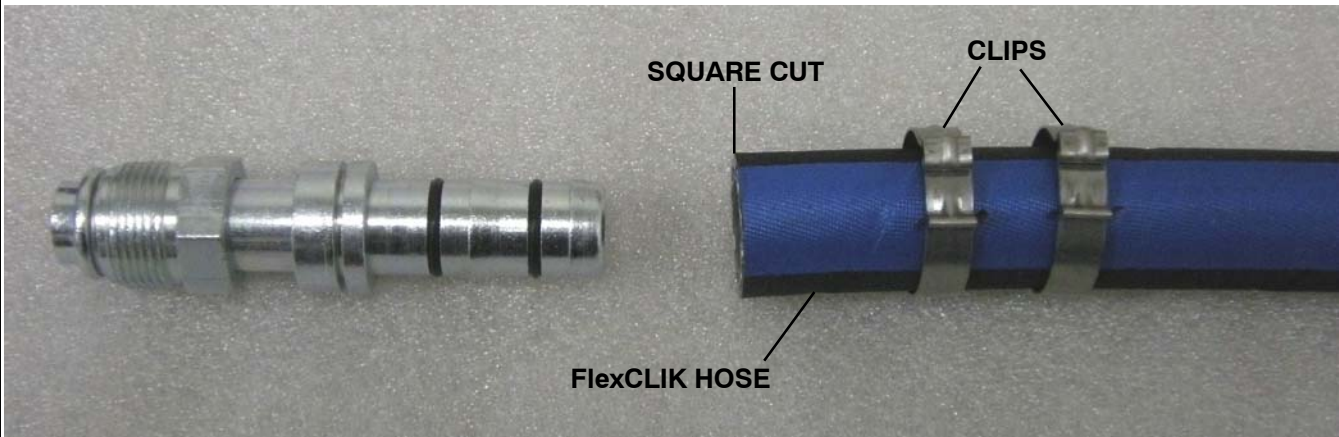

### Step 3: Oil the Nipple

Lubricate the fitting with a generous amount of mineral oil or the A/C system's compressor lubricating oil. This **MUST** be done to lower the force of fitting insertion.

**CARRIER TAC Recommends Mineral OIL**





**Step 4: Insert the Nipple into the Hose**

To ensure that the fitting is fully inserted, check the gap between the cut end of the hose and the shoulder of the fitting. Care should be taken to avoid kinking or other damage to the hose during fitting insertion.

**NOTE:** Be sure to wipe excess oil from the nipple and hose

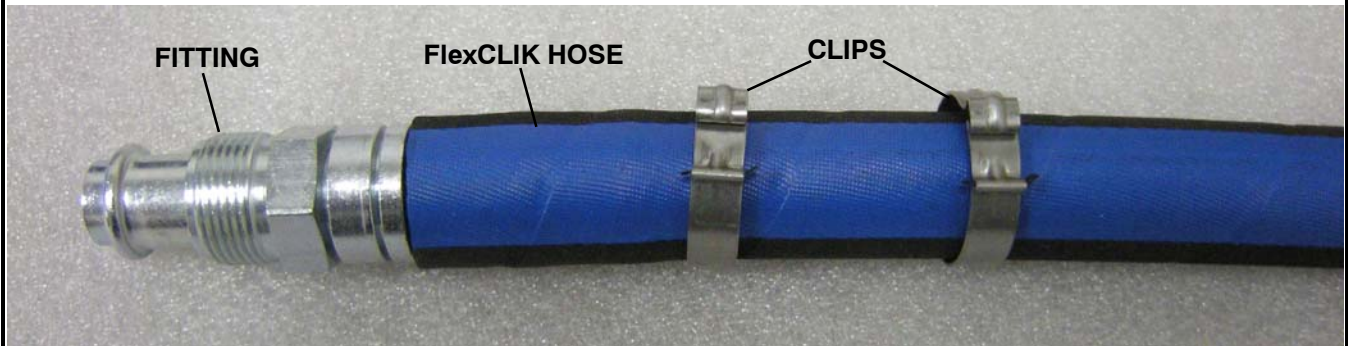

**Step 5: Snap on the Cage**

Snap the cage into the groove on the fitting. The arms should extend over the hose length. When the cage has been correctly installed in the cage groove, the cage will be able to rotate in the groove. This step **MUST** be performed to ensure:

1. The clips will be located over the O-Rings on the fitting.
2. The connection will be compatible with the connection's pressure rating

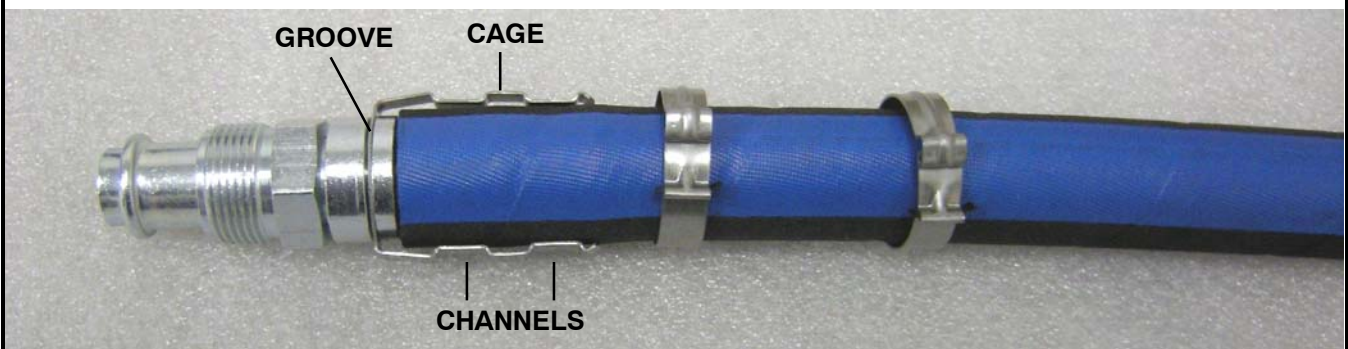

**Step 6: Slide the Clips**

Slide the clips over the cage arms and into the channels on each arm. **SEE BELOW**



### Step 7: Close the Clips

Use the FlexCLIK pliers to close the clips. The pliers should be positioned squarely on the clip connection points and should remain square during the closing of the clip. **SEE BELOW**



Nose of the pliers should be firmly seated under the assembly bump and lock latch. If the pliers are not kept square during closing of the clip, the clasp may have an off-set. Use the pliers to correct the clasp alignment.



**Notice:** FlexCLIK components should not be reused. For recommendations on cleaning and routing hose assemblies, please consult "Carrier Transport Air Conditioning INSTALLATION PROCEDURES manual T-311.

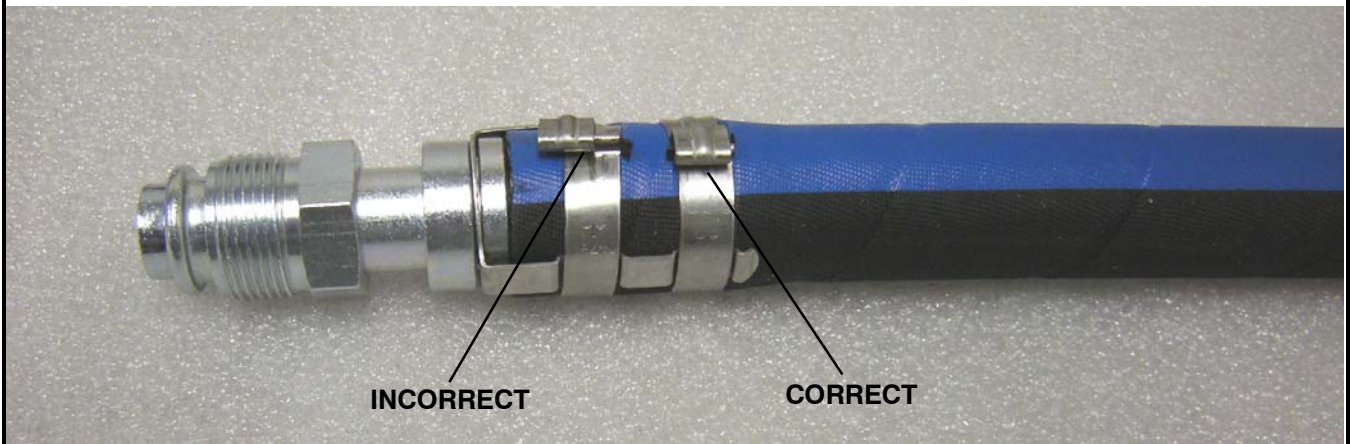
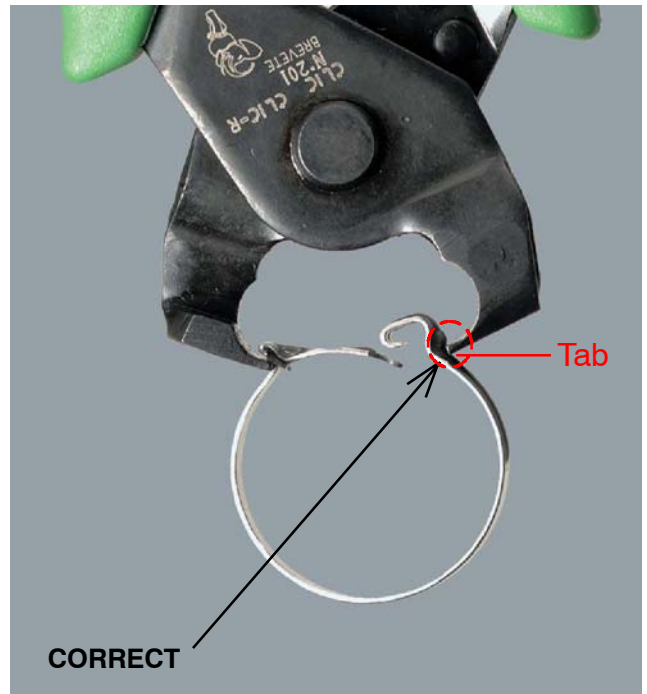

**⚠ WARNING**

FAILURE TO FOLLOW THESE ASSEMBLY INSTRUCTIONS AND/OR THE USE OF CARRIER FlexCLIK HOSE WITH FITTINGS SUPPLIED BY OTHER MANUFACTURERS MAY RESULT IN UNRELIABLE AND UNSAFE HOSE ASSEMBLIES, WHICH MAY RESULT IN SUDDEN OR UNINTENDED ESCAPE OF REFRIGERANT GASES. PERSONAL INJURY AND/OR VIOLATIONS OF EPA REGULATIONS MAY OCCUR AS A CONSEQUENCE.

**⚠ CAUTION**

CARRIER TRANSICOLD RECOMMENDS ADHERENCE TO ALL GUIDELINES, INCLUDING EPA GUIDELINES, CONCERNING THE SERVICE OF AIR CONDITIONING SYSTEMS.



### SECTION 3

## FlexCLIK FITTINGS & Quick-CLICK CROSS-REFERENCE

### FlexCLIK FITTING PART NUMBER - KITTED

#### NOTE:

FlexCLIK Fitting Assemblies are sold as Kits. The FlexCLIK Fitting Kit will include: (1) fitting, (2) FlexCLIK Hose Clamps (Clips) & (1) Cage, all in a PPG pre-printed plastic bag with Bar Code, hose fitting color strip, date code and fitting description (See example below).

#### FlexCLIK - KITTED PARTS



<b>FlexCLIK - CROSS REFERENCE - FlexCLIK &amp; Quick-CLICK</b>			
<b>FITTING KIT PART NUMBER</b>	<b>INDIVIDUAL FITTING (NSS)</b>	<b>INDIVIDUAL FITTING DESCRIPTION</b>	<b>Quick-CLICK PART NUMBER</b>
40-62101-50	40-62101-00	90°, #10 FOR X #10 Hose, FlexCLIK	40-62023-01
40-62101-51	40-62101-01	90°, #12 FOR X #12 Hose, FlexCLIK	N/A
40-62101-55	40-62101-05	90°, #10 FOR X #12 Hose, FlexCLIK	40-62023-00
40-62101-56	40-62101-06	90°, #10 FOR X #16 Hose, FlexCLIK	N/A
40-62101-57	40-62101-07	90°, #12 FOR X #16 Hose, FlexCLIK	N/A
40-62102-50	40-62102-00	TEE, #8 X #8 X #8 Hose, FlexCLIK	40-62012-00
40-62102-51	40-62102-01	TEE, #10 X #10 X #10 Hose, FlexCLIK	40-62012-02
40-62102-52	40-62102-02	TEE, #12 X #12 X #12 Hose, FlexCLIK	40-62012-01
40-62103-50	40-62103-00	90°, #8 FOR X #10 Hose, W/HSA, FlexCLIK	40-62022-00
40-62103-51	40-62103-01	90°, #8 FOR X #8 Hose, W/HSA, FlexCLIK	40-62022-01
40-62112-50	40-62112-00	Splicer, #6 Hose, FLX, With 1/4 Inch Schrader	40-60081-02
40-62112-51	40-62112-01	Splicer, #8 Hose, FLX, With 1/4 Inch Schrader	40-60081-03
40-62112-52	40-62112-02	Splicer, #10 Hose, FLX, With 1/4 Inch Schrader	40-60081-04
40-62112-53	40-62112-03	Splicer, #12 Hose, FLX, With 1/4 Inch Schrader	40-60081-05
40-62112-54	40-62112-04	Splicer, #16 Hose, FLX, With 1/4 Inch Schrader	N/A
40-62127-50	40-62127-00	"Y" Splicer, #8 X #8 X #8 FlexCLIK	40-62017-00
40-62127-51	40-62127-01	"Y" Splicer, #10 X #10 X #10 FlexCLIK	N/A
40-62127-52	40-62127-02	"Y" Splicer, #10 X #10 X #12 FlexCLIK	N/A
40-62127-53	40-62127-03	"Y" Splicer, #12 X #12 X #12 FlexCLIK	40-62017-01
40-62127-54	40-62127-04	"Y" Splicer, #12 X #12 X #16 FlexCLIK	N/A
40-62128-52	40-62128-02	Splicer, #6 Hose, FlexCLIK	40-60086-02
40-62128-53	40-62128-03	Splicer, #8 Hose, FlexCLIK	40-60086-03
40-62128-54	40-62128-04	Splicer, #10 Hose, FlexCLIK	40-60086-04
40-62128-55	40-62128-05	Splicer, #12 Hose, FlexCLIK	40-60086-05
40-62128-56	40-62128-06	Splicer, #16 Hose, FlexCLIK	N/A
40-62130-50	40-62130-00	45°, #6 MOR X #8 Hose, FlexCLIK	40-60084-06
40-62130-51	40-62130-01	45°, #10 MOR X #12 Hose, FlexCLIK	40-60084-05
40-62130-52	40-62130-02	45°, #10 MOR X #16 Hose, FlexCLIK	N/A
40-62130-53	40-62130-03	45°, #12 MOR X #12 Hose, FlexCLIK	N/A
40-62130-54	40-62130-04	45°, #6 MOR X #6 Hose, FlexCLIK	N/A
40-62131-50	40-62131-00	90°, Splicer, #8 Hose, FlexCLIK	40-60137-03
40-62131-51	40-62131-01	90°, Splicer, #10 Hose, FlexCLIK	40-60137-04
40-62131-52	40-62131-02	90°, Splicer, #12 Hose, FlexCLIK	40-60137-05
40-62132-50	40-62132-00	90°, #6 Pilot O-Ring X #8 Hose, FlexCLIK	N/A
40-62132-51	40-62132-01	90°, #10 Pilot O-Ring X #12 Hose, FlexCLIK	N/A
40-62133-50	40-62133-00	90°, Metric 20, MI O-Ring X #10 Hose, FlexCLIK	N/A
40-62134-50	40-62134-00	90°, MI O-Ring X #8 Hose, FlexCLIK	N/A
40-62134-51	40-62134-01	90°, MI O-Ring X #10 Hose, FlexCLIK	N/A
40-62135-50	40-62130-00	90°, Metric 20 FOR X #10 Hose, FlexCLIK	N/A
40-62135-51	40-62130-01	90°, Metric 27 FOR X #12 Hose, FlexCLIK	N/A
40-62135-52	40-62130-02	90°, Metric 20 FOR W/Access X #8 Hose	N/A
40-62136-50	40-62136-00	90°, GM Block X #10 Hose, FlexCLIK	40-62088-00
40-62136-51	40-62136-01	90°, GM Block X #12 Hose, FlexCLIK	40-62089-00
40-62144-50	40-62144-00	180°, #6 Female O-Ring X #8 Hose, FlexCLIK	N/A
40-62144-51	40-62144-01	180°, #10 Female O-Ring X #12 Hose, FlexCLIK	N/A

**FlexCLIK - CROSS REFERENCE - FlexCLIK & Quick-CLICK - Continued:**

<b>FITTING KIT PART NUMBER</b>	<b>INDIVIDUAL FITTING (NSS)</b>	<b>INDIVIDUAL FITTING DESCRIPTION</b>	<b>Quick-CLICK PART NUMBER</b>
40-64073-50	40-64073-00	90°, #6 FFL X #6 Hose, FlexCLIK	40-60079-02
40-64073-51	40-64073-01	90°, #6 FFL X #8 Hose, FlexCLIK	N/A
40-64073-52	40-64073-02	90°, #8 FFL X #8 Hose, FlexCLIK	40-60079-03
40-64073-53	40-64073-03	90°, #10 FFL X #10 Hose, FlexCLIK	40-60079-04
40-64073-54	40-64073-04	90°, #10 FFL X #12 Hose, FlexCLIK	40-60079-07
40-64073-55	40-64073-05	90°, #12 FFL X #12 Hose, FlexCLIK	40-60079-05
40-64074-50	40-64074-00	#6 Straight, FOR X #6 Hose, FlexCLIK	40-60060-02
40-64074-51	40-64074-01	#6 Straight, FOR X #8 Hose, FlexCLIK	40-60060-08
40-64074-52	40-64074-02	#8 Straight, FOR X #8 Hose, FlexCLIK	40-60060-03
40-64074-53	40-64074-03	#8 Straight, FOR X #10 Hose, FlexCLIK	40-60060-06
40-64074-54	40-64074-04	#10 Straight, FOR X #10 Hose, FlexCLIK	40-60060-04
40-64074-55	40-64074-05	#10 Straight, FOR X #12 Hose, FlexCLIK	40-60060-07
40-64074-56	40-64074-06	#12 Straight, FOR X #12 Hose, FlexCLIK	40-60060-05
40-64074-57	40-64074-07	#10 Straight, FOR X #8 Hose, FlexCLIK	N/A
40-64074-58	40-64074-08	#12 Straight, FOR X #10 Hose, FlexCLIK	N/A
40-64074-59	40-64074-09	#10 Straight, FOR X #16 Hose, FlexCLIK	N/A
40-64074-60	40-64074-10	#12 Straight, FOR X #16 Hose, FlexCLIK	N/A
40-64075-50	40-64075-00	90°, #6 FOR X #6 Hose, FlexCLIK	40-60061-02
40-64075-51	40-64075-01	90°, #6 FOR X #8 Hose, FlexCLIK	40-60061-08
40-64075-52	40-64075-02	90°, #8 FOR X #8 Hose, FlexCLIK	40-60061-03
40-64075-53	40-64075-03	90°, #8 FOR X #10 Hose, FlexCLIK	40-60061-06
40-64075-54	40-64075-04	90°, #10 FOR X #10 Hose, FlexCLIK	40-60061-04
40-64075-55	40-64075-05	90°, #10 FOR X #12 Hose, FlexCLIK	40-60061-07
40-64075-56	40-64075-06	90°, #12 FOR X #12 Hose, FlexCLIK	40-60061-05
40-64075-57	40-64075-07	90°, #8 FOR X #6 Hose, FlexCLIK	N/A
40-64075-58	40-64075-08	90°, #12 FOR X #10 Hose, FlexCLIK	N/A
40-64075-59	40-64075-09	90°, #12 FOR X #16 Hose, FlexCLIK	N/A
40-64075-60	40-64075-10	90°, #10 FOR X #16 Hose, FlexCLIK	N/A
40-64080-50	40-64080-00	90°, #10 MOR X #12 Hose, FlexCLIK	40-60083-07
40-64080-51	40-64080-01	90°, #6 MOR X #8 Hose, FlexCLIK	40-60083-08
40-64080-52	40-64080-02	90°, #12 MOR X #12 Hose, FlexCLIK	N/A
40-64080-53	40-64080-03	90°, #8 MOR X #10 Hose, FlexCLIK	N/A
40-64080-56	40-64080-06	90°, #6 MOR X #6 Hose, FlexCLIK	40-60083-02
40-64080-57	40-64080-07	90°, #8 MOR X #8 Hose, FlexCLIK	40-60083-03
40-64080-58	40-64080-08	90°, #10 MOR X #12 Hose, FlexCLIK	40-60083-04
40-64080-59	40-64080-09	90°, #12 MOR X #10 Hose, FlexCLIK	N/A
40-64081-50	40-64081-00	Straight, #6 MOR X #8 Hose, FlexCLIK	40-60051-08
40-64081-51	40-64081-01	Straight, #10 MOR X #12 Hose, FlexCLIK	40-60051-07
40-64081-52	40-64081-02	Straight, #8 MOR X #8 Hose, FlexCLIK	40-60051-03
40-64081-53	40-64081-03	Straight, #6 MOR X #6 Hose, FlexCLIK	40-60051-02
40-64081-54	40-64081-04	Straight, #10 MOR X #10 Hose, FlexCLIK	40-60051-04
40-64081-55	40-64081-05	Straight, #12 MOR X #12 Hose, FlexCLIK	N/A
40-64081-56	40-64081-06	Straight, #10 MOR X #16 Hose, FlexCLIK	N/A
40-64081-57	40-64081-07	Straight, #12 MOR X #16 Hose, FlexCLIK	N/A



**FlexCLIK - CROSS REFERENCE - FlexCLIK & Quick-CLICK - Continued:**

<b>FITTING KIT PART NUMBER</b>	<b>INDIVIDUAL FITTING (NSS)</b>	<b>INDIVIDUAL FITTING DESCRIPTION</b>	<b>Quick-CLICK PART NUMBER</b>
40-64082-50	40-64082-00	Straight, #10 MOR X #10 Hose, HS, FlexCLIK	N/A
40-64082-51	40-64082-01	Straight, #6 MOR X #6 Hose, HS, FlexCLIK	N/A
40-64082-52	40-64082-02	Straight, #8 MOR X #8 Hose, HS, FlexCLIK	N/A
40-64084-50	40-64084-00	Straight, #8 FFL X #8 Hose, FlexCLIK	40-60078-03
40-64084-51	40-64084-01	Straight, #6 FFL X #8 Hose, FlexCLIK	N/A
40-64084-52	40-64084-02	Straight, #12 FFL X #12 Hose, FlexCLIK	40-60078-05
40-64084-53	40-64084-03	Straight, #8 FFL X #10 Hose, FlexCLIK	40-60078-06
40-64084-54	40-64084-04	Straight, #10 FF X #10 Hose, FlexCLIK	40-60078-04
40-64084-55	40-64084-05	Straight, #6 FFL X #6 Hose, FlexCLIK	40-60078-02
40-64084-56	40-64084-06	Straight, #10 FFL X #12 Hose, FlexCLIK	40-60078-07
40-64089-50	40-64089-00	Straight, #6 MIO X #6 Hose, FlexCLIK	N/A
40-64089-51	40-64089-01	Straight, #8 MIO X #8 Hose, FlexCLIK	N/A
40-64089-52	40-64089-02	Straight, #10 MIO X #10 Hose, FlexCLIK	N/A
40-64089-53	40-64089-03	Straight, #10 MIO X #12 Hose, FlexCLIK	N/A
40-64089-54	40-64089-04	Straight, #12 MIO X #12 Hose, FlexCLIK	N/A
40-64092-50	40-64092-00	90°, #10 FOR X #10 Hose W/1/4 Schrader, FLK	N/A
40-64092-51	40-64092-01	90°, #12 FOR X #12 Hose W/1/4 Schrader, FLK	N/A
40-64094-50	40-64094-00	90°, #10 F.Swivel, ORS X #10 Hose, FlexCLIK	40-60048-04
40-64094-51	40-64094-01	90°, #6 F.Swivel, ORS X #6 Hose, FlexCLIK	40-60048-02
40-64094-52	40-64094-02	90°, #8 F.Swivel, ORS X #8 Hose, FlexCLIK	40-60048-03
40-64094-53	40-64094-03	90°, #12 F.Swivel, ORS X #12 Hose, FlexCLIK	40-60048-05
40-64094-54	40-64094-04	90°, #4 F.Swivel, ORS X #6 Hose, FlexCLIK	40-60048-01
40-64094-55	40-64094-05	90°, #10 F.Swivel, ORS X #12 Hose, FlexCLIK	40-60048-07
40-64094-56	40-64094-06	90°, #8 F.Swivel, ORS X #6 Hose, FlexCLIK	40-60048-10
40-64094-57	40-64094-07	90°, #10 F.Swivel, ORS X #16 Hose, FlexCLIK	N/A
40-64094-58	40-64094-08	90°, #10 F.Swivel, ORS X #12 Hose, FlexCLIK	N/A
40-64095-50	40-64095-00	Splicer, #10 Hose, FlexCLIK, W/High Side Access	40-60059-04
40-64095-51	40-64095-01	Splicer, #6 Hose, FlexCLIK, W/High Side Access	40-60059-02
40-64095-52	40-64095-02	Splicer, #8 Hose, FlexCLIK, W/High Side Access	40-60059-03
40-64106-50	40-64106-00	45°, #12 FOR X #12 Hose, FlexCLIK	40-60050-05
40-64106-51	40-64106-01	45°, #6 FOR X #6 Hose, FlexCLIK	40-60050-02
40-64106-52	40-64106-02	45°, #6 FOR X #8 Hose, FlexCLIK	40-60050-08
40-64106-53	40-64106-03	45°, #8 FOR X #8 Hose, FlexCLIK	40-60050-03
40-64106-54	40-64106-04	45°, #8 FOR X #10 Hose, FlexCLIK	40-60050-06
40-64106-55	40-64106-05	45°, #10 FOR X #10 Hose, FlexCLIK	40-60050-04
40-64106-56	40-64106-06	45°, #10 FOR X #12 Hose, FlexCLIK	40-60050-07
40-64106-57	40-64106-07	45°, #12 FOR X #16 Hose, FlexCLIK	N/A
40-64106-58	40-64106-08	45°, #10 FOR X #16 Hose, FlexCLIK	N/A
40-64115-50	40-64115-00	Splicer, #10 Hose, FlexCLIK, W/Low Side Access	40-60058-04
40-64115-51	40-64115-01	Splicer, #12 Hose, FlexCLIK, W/Low Side Access	40-60058-05
40-64115-52	40-64115-02	Splicer, #16 Hose, FlexCLIK, W/Low Side Access	40-64115-52

**SECTION 4**  
**FlexCLIK FITTINGS**

**O-RING PILOT THREAD SIZES**

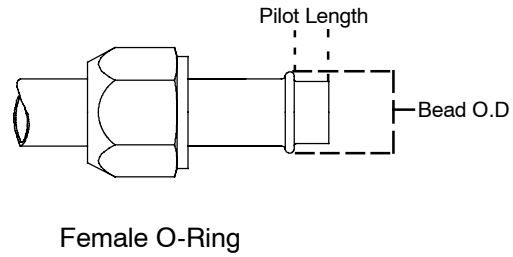
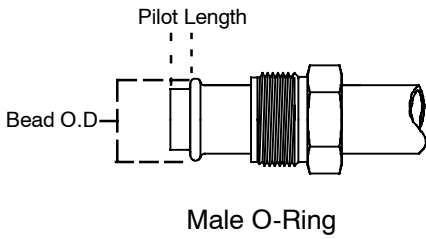

Male Thread O.D (Inch)					Female Thread I.D. (Inch)		
Inch Size	Dash Size	Thread	Fraction	Decimal	Thread	Fraction	Decimal
3/8	06	5/8-18	5/8	.62	5/8-18	9/16	.57
1/2	08	3/4-18	3/4	.75	3/4-16	11/16	.69
5/8	10	7/8-18	7/8	.87	7/8-14	13/16	.81
3/4	12	1-1/16-16	1-1/16	1.06	11/16-14	1	.99

Long Pilot				Short Pilot	
Inch Size	Nom. Tube Size	Bead O.D (Inch)	Pilot Length	Bead O.D. (Inch)	Pilot Length
3/8	06	.52	.28	.52	.19
1/2	08	.64	.39	.64	.19
5/8	10	.77	.39	.77	.19
3/4	12	.91	.39	.91	.19

This connection is common to air conditioning systems, both in vehicle and commercial applications. Both the male and female halves of the connections have a pilot, either long or short. The seal takes place by compressing an O-Ring adjacent to the bead of the tube. The threads hold the connection together mechanically.

**FITTING, 90 DEGREE FEMALE O-RING - LOW SIDE PORT**

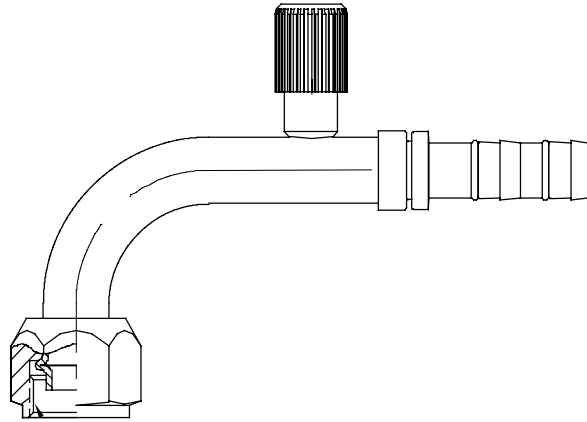

**Kit Includes (1) fitting, (2) FlexCLIK Hose Clamps (Clips) & (1) Cage**

FITTING KIT PART NUMBER	INDIVIDUAL FITTING DESCRIPTION
40-62101-50	Fitting, 90°, #10 FOR (Short Pilot) W/R134a Low Side Port X #10 Hose
40-62101-51	Fitting, 90°, #12 FOR (Short Pilot) W/R134a Low Side Port X #12 Hose
40-62101-55	Fitting, 90°, #10 FOR (Short Pilot) W/R134a Low Side Port X #12 Hose
40-62101-56	Fitting, 90°, #10 FOR (Short Pilot) W/R134a Low Side Port X #16 Hose
40-62101-57	Fitting, 90°, #12 FOR (Short Pilot) W/R134a Low Side Port X #16 Hose

**FITTING, TEE**

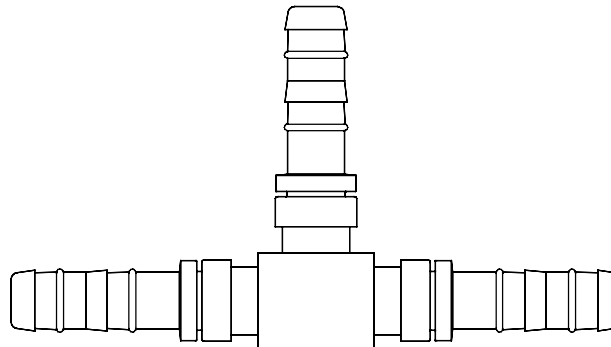

**Kit Includes (1) fitting, (6) FlexCLIK Hose Clamps (Clips) & (3) Cages**

FITTING KIT PART NUMBER	INDIVIDUAL FITTING DESCRIPTION
40-62102-50	Fitting, TEE, #8 X #8 X #8 Hose, FlexCLIK
40-62102-51	Fitting, TEE, #10 X #10 X #10 Hose, FlexCLIK
40-62102-52	Fitting, TEE, #12 X #12 X #12 Hose, FlexCLIK

**FITTING, 90 DEGREE FEMALE O-RING - HIGH SIDE PORT**

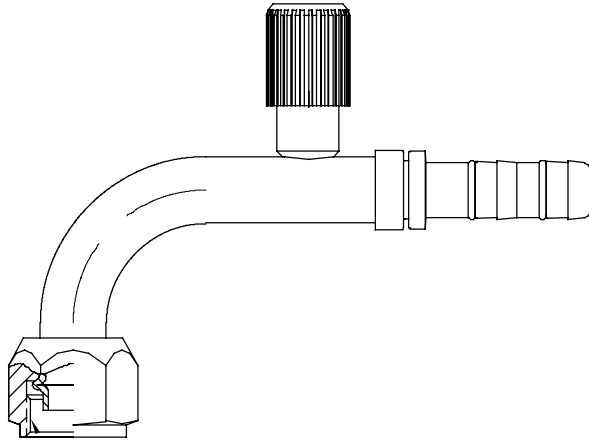

**Kit Includes (1) fitting, (2) FlexCLIK Hose Clamps (Clips) & (1) Cage**

FITTING KIT PART NUMBER	INDIVIDUAL FITTING DESCRIPTION
40-62103-50	Fitting, 90°, #8 FOR With R134a High Side Port X #10 Hose
40-62103-51	Fitting, 90°, #8 FOR With R134a High Side Port X #8 Hose,

**FITTING, HOSE SPLICER, WITH 1/4 SCHRADER**

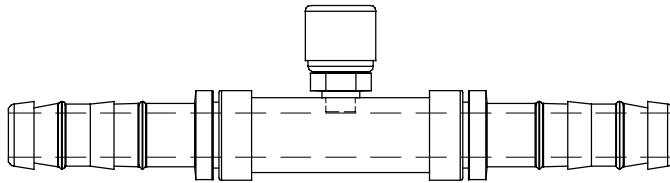

**Kit Includes (1) fitting, (4) FlexCLIK Hose Clamps (Clips) & (2) Cages**

FITTING KIT PART NUMBER	INDIVIDUAL FITTING DESCRIPTION
40-62112-50	Fitting, Splicer, #6 Hose, FlexCLIK Hose, With 1/4 Inch Schrader
40-62112-51	Fitting, Splicer, #8 Hose, FlexCLIK Hose, With 1/4 Inch Schrader
40-62112-52	Fitting, Splicer, #10 Hose, FlexCLIK Hose, With 1/4 Inch Schrader
40-62112-53	Fitting, Splicer, #12 Hose, FlexCLIK Hose, With 1/4 Inch Schrader
40-62112-54	Fitting, Splicer, #16 Hose, FlexCLIK Hose, With 1/4 Inch Schrader

**FITTING, "Y"**

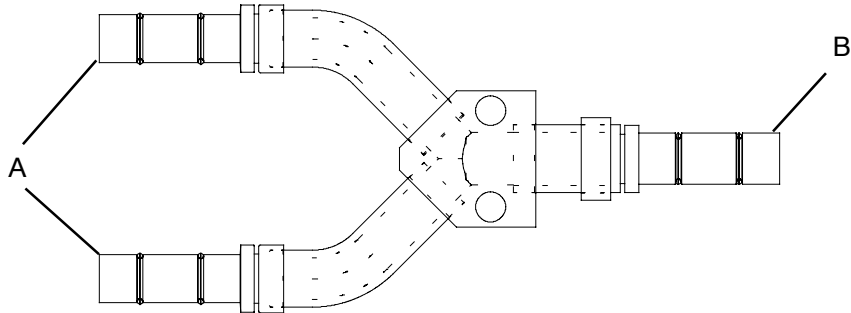

**Kit Includes (1) fitting, (6) FlexCLIK Hose Clamps (Clips) & (3) Cages**

FITTING KIT PART NUMBER	INDIVIDUAL FITTING DESCRIPTION
40-62127-50	Fitting, "Y", 8(A) x 8(A) to 8(B), FlexCLIK Hose
40-62127-51	Fitting, "Y", 10(A) x 10(A) to 10(B), FlexCLIK Hose
40-62127-52	Fitting, "Y", 10(A) x 10(A) to 12(B), FlexCLIK Hose
40-62127-53	Fitting, "Y", 12(A) x 12(A) to 12(B), FlexCLIK Hose
40-62127-54	Fitting, "Y", 12(A) x 12(A) to 16(B), FlexCLIK Hose

**FITTING, HOSE SPLICER**

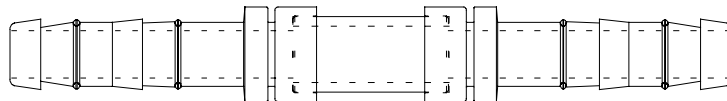

**Kit Includes (1) fitting, (4) FlexCLIK Hose Clamps (Clips) & (2) Cages**

FITTING KIT PART NUMBER	INDIVIDUAL FITTING DESCRIPTION
40-62128-52	Fitting, Splicer, #6 Hose, FlexCLIK Hose
40-62128-53	Fitting, Splicer, #8 Hose, FlexCLIK Hose
40-62128-54	Fitting, Splicer, #10 Hose, FlexCLIK Hose
40-62128-55	Fitting, Splicer, #12 Hose, FlexCLIK Hose
40-62128-56	Fitting, Splicer, #16 Hose, FlexCLIK Hose

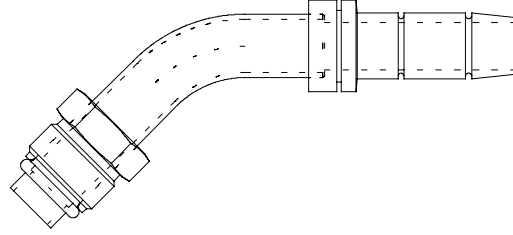
**FITTING, 45 DEGREE, MALE O-RING**

**Kit Includes (1) fitting, (2) FlexCLIK Hose Clamps (Clips) & (1) Cage**

FITTING KIT PART NUMBER	INDIVIDUAL FITTING DESCRIPTION
40-62130-50	Fitting, 45°, #6 MOR X #8 Hose, FlexCLIK
40-62130-51	Fitting, 45°, #10 MOR X #12 Hose, FlexCLIK
40-62130-52	Fitting, 45°, #10 MOR X #16 Hose, FlexCLIK
40-62130-53	Fitting, 45°, #12 MOR X #12 Hose, FlexCLIK
40-62130-54	Fitting, 45°, #6 MOR X #6 Hose, FlexCLIK

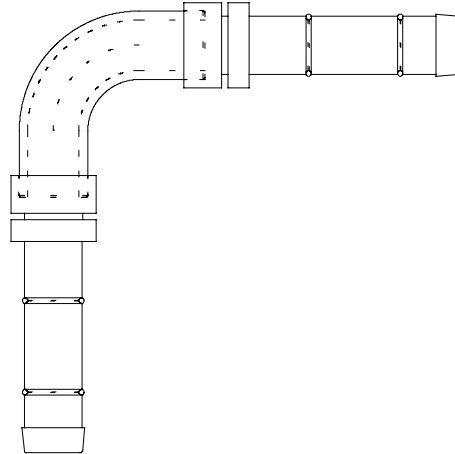
**FITTING, 90 DEGREE SPLICER**

**Kit Includes (1) fitting, (4) FlexCLIK Hose Clamps (Clips) & (2) Cages**

FITTING KIT PART NUMBER	INDIVIDUAL FITTING DESCRIPTION
40-62131-50	Fitting, 90°, Splicer, #8 Hose, FlexCLIK
40-62131-51	Fitting, 90°, Splicer, #10 Hose, FlexCLIK
40-62131-52	Fitting, 90°, Splicer, #12 Hose, FlexCLIK



**FITTING, 90 DEGREE, PILOT O-RING**

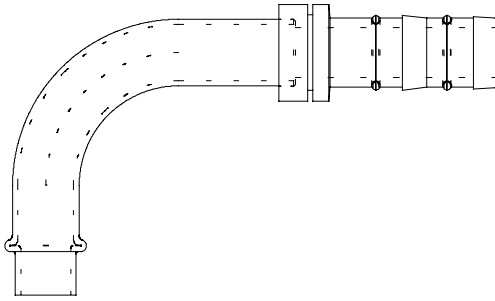

**Kit Includes (1) fitting, (2) FlexCLIK Hose Clamps (Clips) & (1) Cage**

FITTING KIT PART NUMBER	INDIVIDUAL FITTING DESCRIPTION
40-62132-50	Fitting, 90°, #6 Pilot O-Ring X #8 Hose, FlexCLIK
40-62132-51	Fitting, 90°, #10 Pilot O-Ring X #12 Hose, FlexCLIK

**FITTING, 90 DEGREE, METRIC, MALE INSERT O-RING**

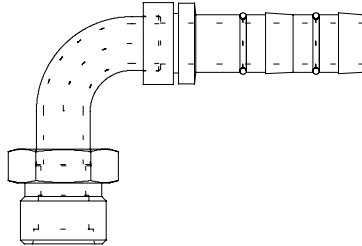

**Kit Includes (1) fitting, (2) FlexCLIK Hose Clamps (Clips) & (1) Cage**

FITTING KIT PART NUMBER	INDIVIDUAL FITTING DESCRIPTION
40-62133-50	Fitting, Metric, 90°, Male Insert O-Ring X #10 Hose, FlexCLIK

**FITTING, 90 DEGREE, METRIC, MALE INSERT O-RING**

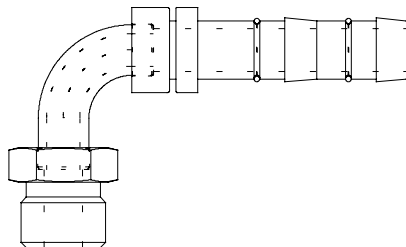

**Kit Includes (1) fitting, (2) FlexCLIK Hose Clamps (Clips) & (1) Cage**

FITTING KIT PART NUMBER	INDIVIDUAL FITTING DESCRIPTION
40-62134-50	Fitting, 90°, Male Insert O-Ring X #8 Hose, FlexCLIK
40-62134-51	Fitting, 90°, Male Insert O-Ring X #10 Hose, FlexCLIK

**FITTING, METRIC, 90 DEGREE, FEMALE O-RING**

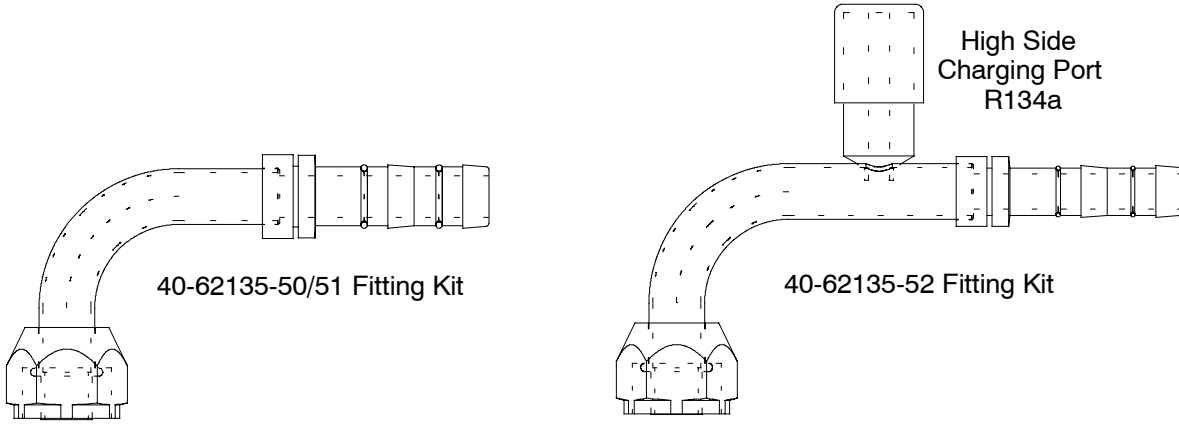

40-62135-50/51 Fitting Kit

40-62135-52 Fitting Kit

**Kit Includes (1) fitting, (2) FlexCLIK Hose Clamps (Clips) & (1) Cage**

FITTING KIT PART NUMBER	INDIVIDUAL FITTING DESCRIPTION
40-62135-50	Fitting (M20 X 1.5), 90°, Female O-Ring X #10 Hose, FlexCLIK
40-62135-51	Fitting (M27 X 2.0), 90°, Female O-Ring X #12 Hose, FlexCLIK
40-62135-52	Fitting (M20 X 1.5 W/HSP), 90°, Female O-Ring X #8 Hose, FlexCLIK

**FITTING, GM BLOCK**

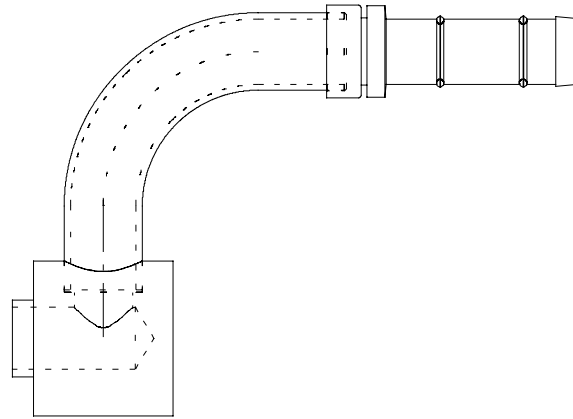

**Kit Includes (1) fitting, (2) FlexCLIK Hose Clamps (Clips) & (1) Cage**

FITTING KIT PART NUMBER	INDIVIDUAL FITTING DESCRIPTION
40-62136-50	Fitting, 90°, GM Block Style X #10 Hose, FlexCLIK
40-62136-51	Fitting, 90°, GM Block Style X #12 Hose, FlexCLIK

**FITTING, 180 DEGREE, FEMALE O-RING**

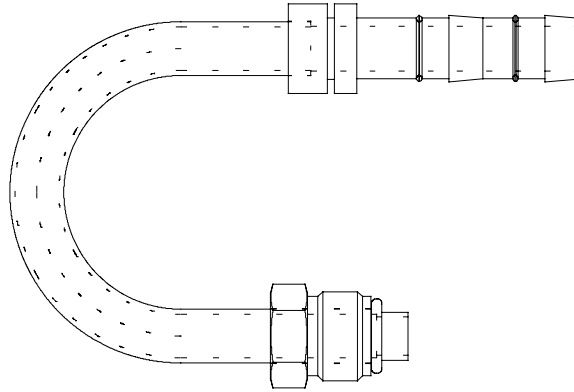

**Kit Includes (1) fitting, (2) FlexCLIK Hose Clamps (Clips) & (1) Cage**

FITTING KIT PART NUMBER	INDIVIDUAL FITTING DESCRIPTION
40-62144-50	Fitting, 180°, #6 Female O-Ring X #8 Hose, FlexCLIK
40-62144-51	Fitting, 180°, #10 Female O-Ring X #12 Hose, FlexCLIK

**FITTING, 90 DEGREE FEMALE FLARE TO FlexCLIK HOSE**

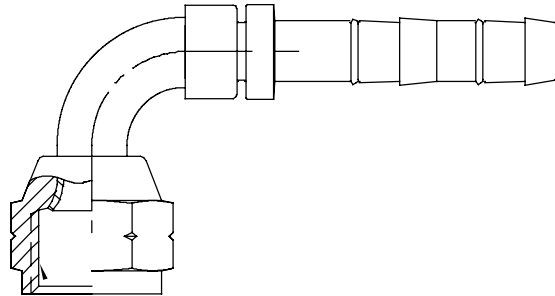

**Kit Includes (1) fitting, (2) FlexCLIK Hose Clamps (Clips) & (1) Cage**

FITTING KIT PART NUMBER	INDIVIDUAL FITTING DESCRIPTION
40-64073-50	Fitting, 90°, #6 Female SAE 45° Flare X #6 Hose, FlexCLIK
40-64073-51	Fitting, 90°, #6 Female SAE 45° Flare X #8 Hose, FlexCLIK
40-64073-52	Fitting, 90°, #8 Female SAE 45° Flare X #8 Hose, FlexCLIK
40-64073-53	Fitting, 90°, #10 Female SAE 45° Flare X #10 Hose, FlexCLIK
40-64073-54	Fitting, 90°, #10 Female SAE 45° Flare X #12 Hose, FlexCLIK
40-64073-55	Fitting, 90°, #12 Female SAE 45° Flare X #12 Hose, FlexCLIK

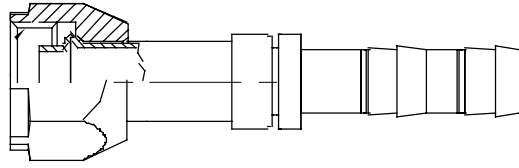
**FITTING, STRAIGHT, FEMALE O-RING**

**Kit Includes (1) fitting, (2) FlexCLIK Hose Clamps (Clips) & (1) Cage**

<b>FITTING KIT PART NUMBER</b>	<b>INDIVIDUAL FITTING DESCRIPTION</b>
40-64074-50	Fitting, #6 Straight, FOR (Short Pilot) X #6 Hose, FlexCLIK
40-64074-51	Fitting, #6 Straight, FOR (Short Pilot) X #8 Hose, FlexCLIK
40-64074-52	Fitting, #8 Straight, FOR (Short Pilot) X #8 Hose, FlexCLIK
40-64074-53	Fitting, #8 Straight, FOR (Short Pilot) X #10 Hose, FlexCLIK
40-64074-54	Fitting, #10 Straight, FOR (Short Pilot) X #10 Hose, FlexCLIK
40-64074-55	Fitting, #10 Straight, FOR (Short Pilot) X #12 Hose, FlexCLIK
40-64074-56	Fitting, #12 Straight, FOR (Short Pilot) X #12 Hose, FlexCLIK
40-64074-57	Fitting, #10 Straight, FOR (Short Pilot) X #8 Hose, FlexCLIK
40-64074-58	Fitting, #12 Straight, FOR (Short Pilot) X #10 Hose, FlexCLIK
40-64074-59	Fitting, #10 Straight, FOR (Short Pilot) X #16 Hose, FlexCLIK
40-64074-60	Fitting, #12 Straight, FOR (Short Pilot) X #16 Hose, FlexCLIK

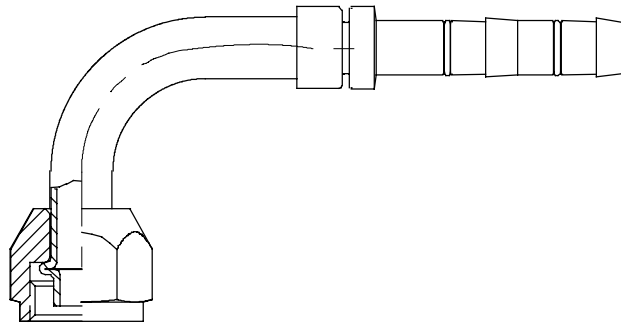
**FITTING, 90 DEGREE FEMALE O-RING**

**Kit Includes (1) fitting, (2) FlexCLIK Hose Clamps (Clips) & (1) Cage**

<b>FITTING KIT PART NUMBER</b>	<b>INDIVIDUAL FITTING DESCRIPTION</b>
40-64075-50	Fitting, 90°, #6 FOR (Short Pilot) X #6 Hose, FlexCLIK
40-64075-51	Fitting, 90°, #6 FOR (Short Pilot) X #8 Hose, FlexCLIK
40-64075-52	Fitting, 90°, #8 FOR (Short Pilot) X #8 Hose, FlexCLIK
40-64075-53	Fitting, 90°, #8 FOR (Short Pilot) X #10 Hose, FlexCLIK
40-64075-54	Fitting, 90°, #10 FOR (Short Pilot) X #10 Hose, FlexCLIK
40-64075-55	Fitting, 90°, #10 FOR (Short Pilot) X #12 Hose, FlexCLIK
40-64075-56	Fitting, 90°, #12 FOR (Short Pilot) X #12 Hose, FlexCLIK
40-64075-57	Fitting, 90°, #8 FOR (Short Pilot) X #6 Hose, FlexCLIK
40-64075-58	Fitting, 90°, #12 FOR (Short Pilot) X #10 Hose, FlexCLIK
40-64075-59	Fitting, 90°, #12 FOR (Short Pilot) X #16 Hose, FlexCLIK
40-64075-60	Fitting, 90°, #10 FOR (Short Pilot) X #16 Hose, FlexCLIK

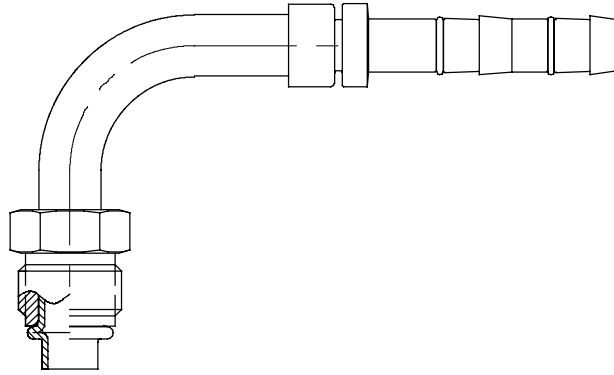
**FITTING, 90 DEGREE MALE O-RING**

**Kit Includes (1) fitting, (2) FlexCLIK Hose Clamps (Clips) & (1) Cage**

<b>FITTING KIT PART NUMBER</b>	<b>INDIVIDUAL FITTING DESCRIPTION</b>
40-64080-50	Fitting, 90°, #10 MOR (Short Pilot) X #12 Hose, FlexCLIK
40-64080-51	Fitting, 90°, #6 MOR (Short Pilot) X #8 Hose, FlexCLIK
40-64080-52	Fitting, 90°, #12 MOR (Short Pilot) X #12 Hose, FlexCLIK
40-64080-53	Fitting, 90°, #8 MOR (Short Pilot) X #10 Hose, FlexCLIK
40-64080-56	Fitting, 90°, #6 MOR (Short Pilot) X #6 Hose, FlexCLIK
40-64080-57	Fitting, 90°, #8 MOR (Short Pilot) X #8 Hose, FlexCLIK
40-64080-68	Fitting, 90°, #10 MOR (Short Pilot) X #10 Hose, FlexCLIK
40-64080-59	Fitting, 90°, #12 MOR (Short Pilot) X #10 Hose, FlexCLIK

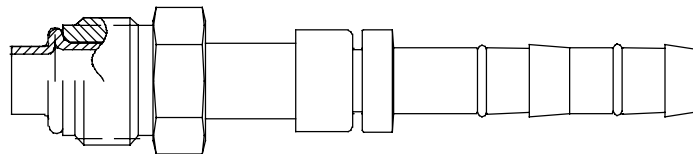
**FITTING, STRAIGHT, MALE O-RING**

**Kit Includes (1) fitting, (2) FlexCLIK Hose Clamps (Clips) & (1) Cage**

<b>FITTING KIT PART NUMBER</b>	<b>INDIVIDUAL FITTING DESCRIPTION</b>
40-64081-50	Fitting, Straight, #6 MOR (Short Pilot) X #8 Hose, FlexCLIK
40-64081-51	Fitting, Straight, #10 MOR (Short Pilot) X #12 Hose, FlexCLIK
40-64081-52	Fitting, Straight, #8 MOR (Short Pilot) X #8 Hose, FlexCLIK
40-64081-53	Fitting, Straight, #6 MOR (Short Pilot) X #6 Hose, FlexCLIK
40-64081-54	Fitting, Straight, #10 MOR (Short Pilot) X #10 Hose, FlexCLIK
40-64081-55	Fitting, Straight, #12 MOR (Short Pilot) X #12 Hose, FlexCLIK
40-64081-56	Fitting, Straight, #10 MOR (Short Pilot) X #16 Hose, FlexCLIK
40-64081-57	Fitting, Straight, #12 MOR (Short Pilot) X #16 Hose, FlexCLIK

**FITTING, STRAIGHT, MALE O-RING WITH HIGH SIDE ACCESS**

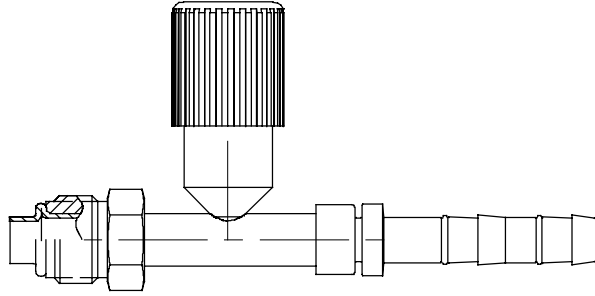

**Kit Includes (1) fitting, (2) FlexCLIK Hose Clamps (Clips) & (1) Cage**

FITTING KIT PART NUMBER	INDIVIDUAL FITTING DESCRIPTION
40-64082-50	Fitting, Straight, #10 MOR (Short Pilot) X #10 Hose, HS, FlexCLIK
40-64082-51	Fitting, Straight, #6 MOR (Short Pilot) X #6 Hose, HS, FlexCLIK
40-64082-52	Fitting, Straight, #8 MOR (Short Pilot) X #8 Hose, HS, FlexCLIK

**FITTING, STRAIGHT**

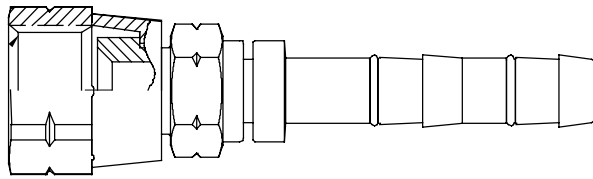

**Kit Includes (1) fitting, (2) FlexCLIK Hose Clamps (Clips) & (1) Cage**

FITTING KIT PART NUMBER	INDIVIDUAL FITTING DESCRIPTION
40-64084-50	Fitting, Straight, #8 Female SAE 45° Flare X #8 Hose, FlexCLIK
40-64084-51	Fitting, Straight, #6 Female SAE 45° Flare X #8 Hose, FlexCLIK
40-64084-52	Fitting, Straight, #12 Female SAE 45° Flare X #12 Hose, FlexCLIK
40-64084-53	Fitting, Straight, #8 Female SAE 45° Flare X #10 Hose, FlexCLIK
40-64084-54	Fitting, Straight, #10 Female SAE 45° Flare X #10 Hose, FlexCLIK
40-64084-55	Fitting, Straight, #6 Female SAE 45° Flare X #6 Hose, FlexCLIK
40-64084-56	Fitting, Straight, #10 Female SAE 45° Flare X #12 Hose, FlexCLIK



**FITTING, STRAIGHT, MALE INSERT O-RING**

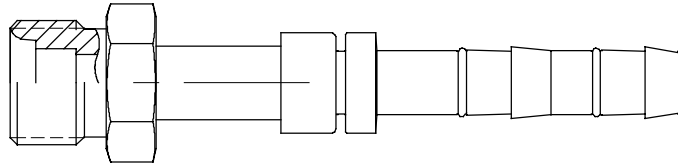

**Kit Includes (1) fitting, (2) FlexCLIK Hose Clamps (Clips) & (1) Cage**

FITTING KIT PART NUMBER	INDIVIDUAL FITTING DESCRIPTION
40-64089-50	Fitting, Straight, #6 Male Insert O-Ring X #6 Hose, FlexCLIK
40-64089-51	Fitting, Straight, #8 Male Insert O-Ring X #8 Hose, FlexCLIK
40-64089-52	Fitting, Straight, #10 Male Insert O-Ring X #10 Hose, FlexCLIK
40-64089-53	Fitting, Straight, #10 Male Insert O-Ring X #12 Hose, FlexCLIK
40-64089-54	Fitting, Straight, #12 Male Insert O-Ring X #12 Hose, FlexCLIK

**FITTING, 90 DEGREE FEMALE O-RING WITH 1/4 SCHRADER**

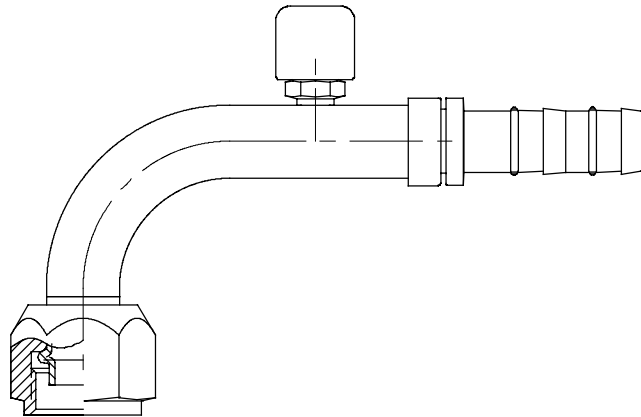

**Kit Includes (1) fitting, (2) FlexCLIK Hose Clamps (Clips) & (1) Cage**

FITTING KIT PART NUMBER	INDIVIDUAL FITTING DESCRIPTION
40-64092-50	Ftg., 90°, #10 FOR (Short Pilot) X #10 Hose W/1/4" SAE Schrader
40-64092-51	Ftg., 90°, #12 FOR (Short Pilot) X #12 Hose W/1/4" SAE Schrader

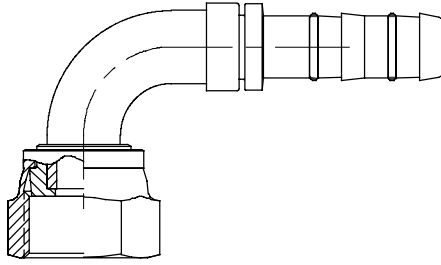
**FITTING, 90 DEGREE FEMALE O-RING SEAL (SWIVEL)**

**Kit Includes (1) fitting, (2) FlexCLIK Hose Clamps (Clips) & (1) Cage**

FITTING KIT PART NUMBER	INDIVIDUAL FITTING DESCRIPTION
40-64094-50	Fitting, 90°, #10 ORS, Female Swivel X #10 Hose, FlexCLIK
40-64094-51	Fitting, 90°, #6 ORS, Female Swivel X #6 Hose, FlexCLIK
40-64094-52	Fitting, 90°, #8 ORS, Female Swivel X #8 Hose, FlexCLIK
40-64094-53	Fitting, 90°, #12 ORS, Female Swivel X #12 Hose, FlexCLIK
40-64094-54	Fitting, 90°, #4 ORS, Female Swivel X #6 Hose, FlexCLIK
40-64094-55	Fitting, 90°, #10 ORS, Female Swivel X #12 Hose, FlexCLIK
40-64094-56	Fitting, 90°, #8 ORS, Female Swivel X #6 Hose, FlexCLIK
40-64094-57	Fitting, 90°, #10 ORS, Female Swivel X #16 Hose, FlexCLIK
40-64094-58	Fitting, 90°, #10 ORS, Female Swivel X #12 Hose, FlexCLIK

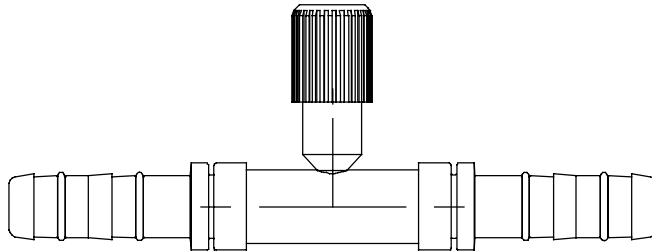
**FITTING, SPLICER, WITH HIGH-SIDE ACCESS**

**Kit Includes (1) fitting, (4) FlexCLIK Hose Clamps (Clips) & (2) Cages**

FITTING KIT PART NUMBER	INDIVIDUAL FITTING DESCRIPTION
40-64095-50	Fitting, Splicer, #10 Hose, FlexCLIK, With High Side R134a Port
40-64095-51	Fitting, Splicer, #6 Hose, FlexCLIK, With High Side R134a Port
40-64095-52	Fitting, Splicer, #8 Hose, FlexCLIK, With High Side R134a Port

**FITTING, 45 DEGREE, FEMALE O-RING**

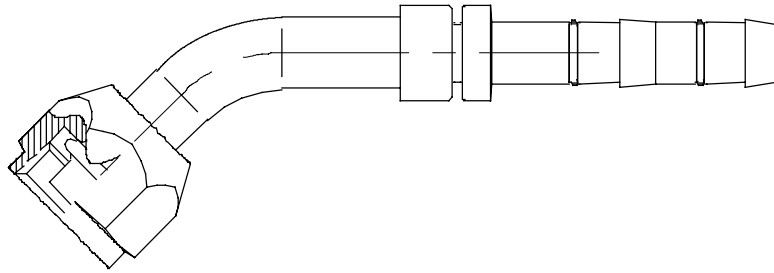

**Kit Includes (1) fitting, (2) FlexCLIK Hose Clamps (Clips) & (1) Cage**

FITTING KIT PART NUMBER	INDIVIDUAL FITTING DESCRIPTION
40-64106-50	Fitting, 45°, #12 FOR (Short Pilot) X #12 Hose, FlexCLIK
40-64106-51	Fitting, 45°, #6 FOR (Short Pilot) X #6 Hose, FlexCLIK
40-64106-52	Fitting, 45°, #6 FOR (Short Pilot) X #8 Hose, FlexCLIK
40-64106-53	Fitting, 45°, #8 FOR (Short Pilot) X #8 Hose, FlexCLIK
40-64106-54	Fitting, 45°, #8 FOR (Short Pilot) X #10 Hose, FlexCLIK
40-64106-55	Fitting, 45°, #10 FOR (Short Pilot) X #10 Hose, FlexCLIK
40-64106-56	Fitting, 45°, #10 FOR (Short Pilot) X #12 Hose, FlexCLIK
40-64106-57	Fitting, 45°, #12 FOR (Short Pilot) X #16 Hose, FlexCLIK
40-64106-58	Fitting, 45°, #10 FOR (Short Pilot) X #16 Hose, FlexCLIK

**FITTING, SPLICER, WITH LOW-SIDE ACCESS**

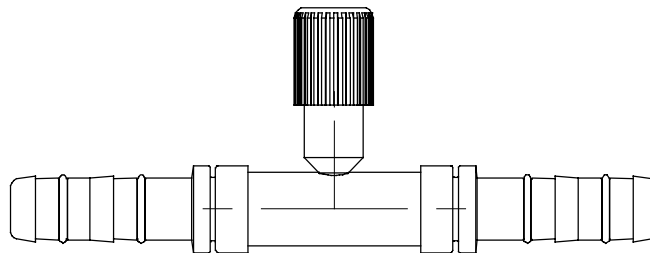

**Kit Includes (1) fitting, (4) FlexCLIK Hose Clamps (Clips) & (2) Cages**

FITTING KIT PART NUMBER	INDIVIDUAL FITTING DESCRIPTION
40-64115-50	Fitting, Splicer, #10 Hose, FlexCLIK, With R134a Low Side Port
40-64115-51	Fitting, Splicer, #12 Hose, FlexCLIK, With R134a Low Side Port
40-64115-52	Fitting, Splicer, #16 Hose, FlexCLIK, With R134a Low Side Port

## SECTION 5

### FlexCLIK HOSE - CLAMPS - CAGES & O-RINGS

#### HOSE, FLEXCLIK

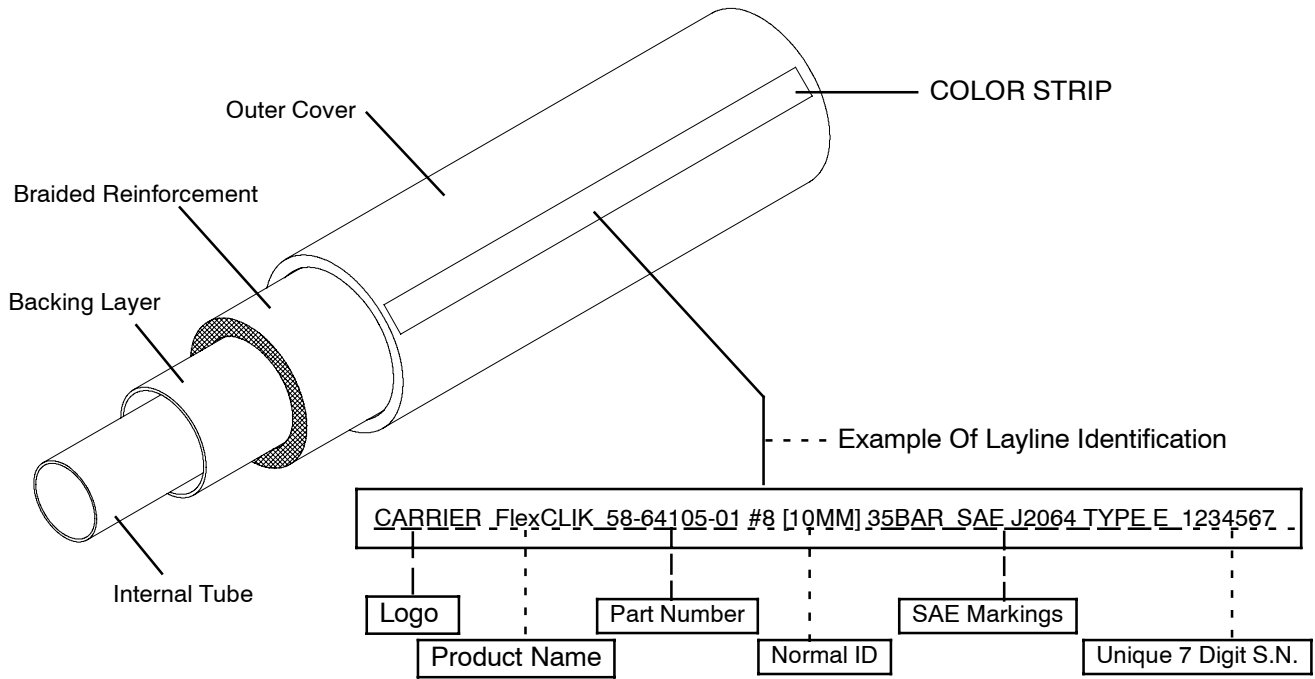

PART NUMBER	HOSE DESCRIPTION
58-64105-90	FlexCLIK Hose, (Black) (5/16) #6 x 50 Foot (8.1 MM I.D X 15.2 MM O. D.)
58-64105-13	FlexCLIK Hose, (Green)(13/32) #8 x 50 Foot (10.7 MM I.D X 18.2 MM O. D.)
58-64105-24	FlexCLIK Hose, (Red) (1/2) #10 x 50 Foot (13.2 MM I.D X 20.3 MM O. D.)
58-64105-34	FlexCLIK Hose, (Blue) (5/8) #12 x 50 Foot (16.3 MM I.D X 25.1 MM O. D.)
58-64105-44	FlexCLIK Hose, (Blue) (7/8) #16 x 50 Foot (16.3 MM I.D X 25.1 MM O. D.)

#### O-RING, FlexCLIK

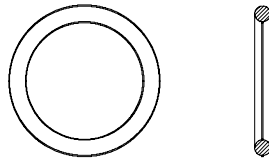

PART NUMBER	O-RING DESCRIPTION
42-62157-00	O-Ring, FlexCLIK Nipple Hose End, #4
42-62157-01	O-Ring, FlexCLIK Nipple Hose End, #6
42-62157-02	O-Ring, FlexCLIK Nipple Hose End, #8
42-62157-03	O-Ring, FlexCLIK Nipple Hose End, #10
42-62157-04	O-Ring, FlexCLIK Nipple Hose End, #12
42-62157-05	O-Ring, FlexCLIK Nipple Hose End, #16

**FlexCLIK CLAMP KITS - CAGE & CLIPS**

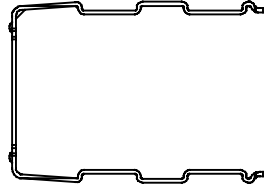

**CAGE - 1 Each**

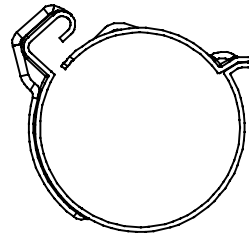

**CLIP - 2 Each**

KIT PART NUMBER	KIT DESCRIPTION
44-64008-50	<b>Includes:</b> 1 Each Cage #6 (44-64008-00) & 2 Each Clips #6 (44-64009-00)
44-64008-51	<b>Includes:</b> 1 Each Cage #8 (44-64008-01) & 2 Each Clips #8 (44-64009-01)
44-64008-52	<b>Includes:</b> 1 Each Cage #10 (44-64008-02) & 2 Each Clips #10 (44-64009-02)
44-64008-53	<b>Includes:</b> 1 Each Cage #12 (44-64008-03) & 2 Each Clips #12 (44-64009-03)
44-64008-54	<b>Includes:</b> 1 Each Cage #16 (44-64008-04) & 2 Each Clips #16 (44-64009-04)

# PART NUMBER INDEX

PART NO.	PAGE NO.	PART NO.	PAGE NO.	PART NO.	PAGE NO.
07-00507-00,	1	40-60061-08,	10	40-62101-01,	9, 13
07-00467-00,	2	40-60078-02,	11	40-62101-05,	9, 13
07-00508-00,	2	40-60078-03,	11	40-62101-50,	9
40-60048-01,	11	40-60078-04,	11	40-62101-51,	9
40-60048-02,	11	40-60078-05,	11	40-62101-55,	9
40-60048-03,	11	40-60078-06,	11	40-62102-00,	9, 13
40-60048-04,	11	40-60078-07,	11	40-62102-01,	9, 13
40-60048-05,	11	40-60079-03,	10	40-62102-02,	9, 13
40-60048-07,	11	40-60079-04,	10	40-62102-50,	9
40-60048-10,	11	40-60079-05,	10	40-62102-51,	9
40-60050-02,	11	40-60079-07,	10	40-62102-52,	9
40-60050-03,	11	40-60081-02,	9	40-62103-00,	9, 14
40-60050-04,	11	40-60081-03,	9	40-62103-01,	9, 14
40-60050-05,	11	40-60081-04,	9	40-62103-50,	9
40-60050-06,	11	40-60081-05,	9	40-62103-51,	9
40-60050-07,	11	40-60083-02,	10	40-62112-00,	9, 14
40-60050-08,	11	40-60083-03,	10	40-62112-01,	9, 14
40-60051-02,	10	40-60083-04,	10	40-62112-02,	9, 14
40-60051-03,	10	40-60083-07,	10	40-62112-03,	9, 14
40-60051-04,	10	40-60083-08,	10	40-62112-04,	9, 14
40-60051-07,	10	40-60084-05,	9	40-62112-50,	9
40-60051-08,	10	40-60084-06,	9	40-62112-51,	9
40-60058-04,	11	40-60086-03,	9	40-62112-52,	9
40-60058-05,	11	40-60086-04,	9	40-62112-53,	9
40-60059-02,	11	40-60086-05,	9	40-62112-54,	9
40-60059-03,	11	40-60137-03,	9	40-62127-00,	15
40-60059-04,	11	40-60137-04,	9	40-62127-01,	15
40-60060-02,	10	40-60137-05,	9	40-62127-02,	15
40-60060-03,	10	40-62012-00,	9	40-62127-03,	15
40-60060-04,	10	40-62012-01,	9	40-62127-04,	15
40-60060-05,	10	40-62012-02,	9	40-62128-03,	9, 15
40-60060-06,	10	40-62017-00,	9	40-62128-04,	9, 15
40-60060-07,	10	40-62017-01,	9	40-62128-05,	9, 15
40-60060-08,	10	40-62022-00,	9	40-62128-06,	9, 15
40-60061-02,	10	40-62022-01,	9	40-62128-53,	9
40-60061-03,	10	40-62023-00,	9	40-62128-54,	9
40-60061-04,	10	40-62023-01,	9	40-62128-55,	9
40-60061-05,	10	40-62088-00,	9	40-62128-56,	9
40-60061-06,	10	40-62089-00,	9	40-62130-00,	9, 16
40-60061-07,	10	40-62101-00,	9, 13	40-62130-01,	9, 16
				40-62130-50,	9



# PART NUMBER INDEX

PART NO.	PAGE NO.	PART NO.	PAGE NO.	PART NO.	PAGE NO.
40-62130-51,	9	40-64074-56,	10	40-64080-59,	10
40-62131-00,	9, 16	40-64074-57,	10	40-64081-00,	10, 21
40-62131-01,	9, 16	40-64074-58,	10	40-64081-01,	10, 21
40-62131-02,	9, 16	40-64074-59,	10	40-64081-02,	10, 21
40-62131-50,	9	40-64074-60,	10	40-64081-03,	10, 21
40-62131-51,	9	40-64075-00,	10, 20	40-64081-04,	10, 21
40-62131-52,	9	40-64075-01,	10, 20	40-64081-05,	10, 21
40-62136-00,	9, 18	40-64075-02,	10, 20	40-64081-06,	10, 21
40-62136-01,	9, 18	40-64075-03,	10, 20	40-64081-07,	10, 21
40-62136-50,	9	40-64075-04,	10, 20	40-64081-50,	10
40-62136-51,	9	40-64075-05,	10, 20	40-64081-51,	10
40-64073-00,	10, 19	40-64075-06,	10, 20	40-64081-52,	10
40-64073-01,	10, 19	40-64075-07,	10, 20	40-64081-53,	10
40-64073-02,	10, 19	40-64075-08,	10, 20	40-64081-54,	10
40-64073-03,	10, 19	40-64075-09,	10, 20	40-64081-55,	10
40-64073-04,	10, 19	40-64075-50,	10	40-64081-56,	10
40-64073-05,	10, 19	40-64075-51,	10	40-64081-57,	10
40-64073-50,	10	40-64075-52,	10	40-64082-00,	11, 22
40-64073-51,	10	40-64075-53,	10	40-64082-01,	11, 22
40-64073-52,	10	40-64075-54,	10	40-64082-02,	11, 22
40-64073-53,	10	40-64075-55,	10	40-64082-50,	11
40-64073-54,	10	40-64075-56,	10	40-64082-51,	11
40-64073-55,	10	40-64075-57,	10	40-64082-52,	11
40-64074-00,	10, 20	40-64075-58,	10	40-64084-00,	11, 22
40-64074-01,	10, 20	40-64075-59,	10	40-64084-01,	11, 22
40-64074-02,	10, 20	40-64080-00,	10, 21	40-64084-02,	11, 22
40-64074-03,	10, 20	40-64080-01,	10, 21	40-64084-03,	11, 22
40-64074-04,	10, 20	40-64080-02,	10, 21	40-64084-04,	11, 22
40-64074-05,	10, 20	40-64080-03,	10, 21	40-64084-05,	11, 22
40-64074-06,	10, 20	40-64080-06,	10, 21	40-64084-06,	11
40-64074-07,	10, 20	40-64080-07,	10, 21	40-64084-50,	11
40-64074-08,	10, 20	40-64080-08,	10, 21	40-64084-51,	11
40-64074-09,	10, 20	40-64080-09,	10, 21	40-64084-52,	11
40-64074-10,	10, 20	40-64080-50,	10	40-64084-53,	11
40-64074-50,	10	40-64080-51,	10	40-64084-54,	11
40-64074-51,	10	40-64080-52,	10	40-64084-55,	11
40-64074-52,	10	40-64080-53,	10	40-64084-56,	11
40-64074-53,	10	40-64080-56,	10	40-64089-00,	11, 23
40-64074-54,	10	40-64080-57,	10	40-64089-01,	11, 23
40-64074-55,	10	40-64080-58,	10	40-64089-02,	11, 23

# PART NUMBER INDEX

PART NO.	PAGE NO.	PART NO.	PAGE NO.	PART NO.	PAGE NO.
40-64089-03,	11, 23	40-64106-02,	11, 25	40-62130-53,	9, 16
40-64089-04,	11, 23	40-64106-03,	11, 25	40-62130-54,	9, 16
40-64089-50,	11	40-64106-04,	11, 25	40-62132-00,	9
40-64089-51,	11	40-64106-05,	11, 25	40-62132-01,	9
40-64089-52,	11	40-64106-06,	11, 25	40-62132-50,	9, 17
40-64089-53,	11	40-64106-07,	11, 25	40-62132-51,	9, 17
40-64089-54,	11	40-64106-08,	11, 25	40-62133-50,	17
40-64092-00,	11, 23	40-64106-50,	11	40-62134-50,	17
40-64092-01,	11, 23	40-64106-51,	11	40-62134-51,	17
40-64092-50,	11	40-64106-52,	11	40-62135-50,	9, 18
40-64092-51,	11	40-64106-53,	11	40-62135-51,	9, 18
40-64094-00,	11, 24	40-64106-54,	11	40-62135-52,	9, 18
40-64094-01,	11, 24	40-64106-55,	11	40-62144-00,	9
40-64094-02,	11, 24	40-64106-56,	11	40-62144-01,	9
40-64094-03,	11, 24	40-64106-57,	11	40-62144-50,	9, 19
40-64094-04,	11, 24	40-64106-58,	11	40-62144-51,	9, 19
40-64094-05,	11, 24	40-64115-00,	11, 25	40-64075-10,	10
40-64094-06,	11, 24	40-64115-01,	1, 25	40-64075-60,	10
40-64094-07,	11, 24	40-64115-02,	11, 25	42-62157-00,	26
40-64094-08,	11, 24	40-64115-50,	11	42-62157-01,	26
40-64094-50,	11	40-64115-51,	11	42-62157-02,	26
40-64094-51,	11	40-64115-52,	11	42-62157-03,	26
40-64094-52,	11	40-60086-02,	9	42-62157-04,	26
40-64094-53,	11	40-62101-06,	9	42-62157-05,	26
40-64094-54,	11	40-62101-07,	9	44-64008-50,	27
40-64094-55,	11	40-62101-56,	9, 13	44-64008-51,	27
40-64094-56,	11	40-62101-57,	9, 13	44-64008-52,	27
40-64094-57,	11	40-62127-02,	9	44-64008-53,	27
40-64094-58,	11	40-62127-52,	9	44-64008-54,	27
40-64095-00,	11, 24	40-62128-02,	9	58-64105-13,	26
40-64095-01,	11, 24	40-62128-52,	9, 15	58-64105-24,	26
40-64095-02,	11, 24	40-62130-00,	9	58-64105-34,	26
40-64095-50,	11	40-62130-01,	9	58-64105-44,	26
40-64095-51,	11	40-62130-02,	9	58-64105-90,	26
40-64095-52,	11	40-62130-03,	9	AC101-708,	2
40-64106-00,	11, 25	40-62130-04,	9	AC101-711,	2
40-64106-01,	11, 25	40-62130-52,	9, 16		

Carrier Transport Air Conditioning  
50 Grumbacher Road  
York PA 17406 USA  
Tel: 1-800-673-2431  
Fax: 1-717-764-0401



**Carrier**

A United Technologies Company

Carrier Transicold Division,  
Carrier Corporation  
Transport Air Conditioning Group  
P.O. Box 4805  
Syracuse, N.Y. 13221 U.S.A

[www.carrier.transicold.com](http://www.carrier.transicold.com)



A member of the United Technologies Corporation family. Stock symbol UTX  
©2010 Carrier Corporation • Printed in U. S. A. 0710