

CL1	CL2	QTY	NUMBER	CHANGE	DATE	BY	CHECK

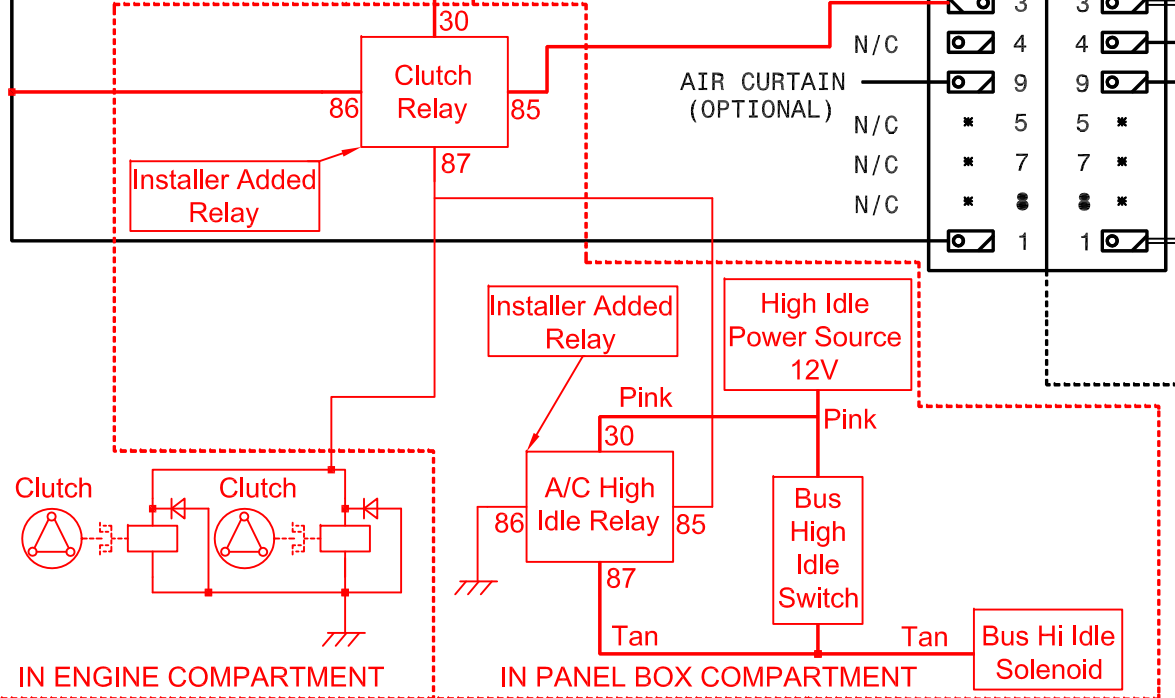

ROOF TOP UNIT

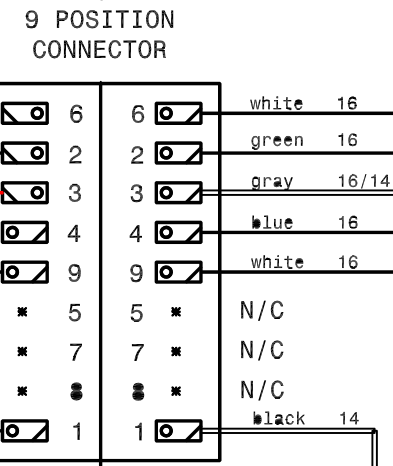
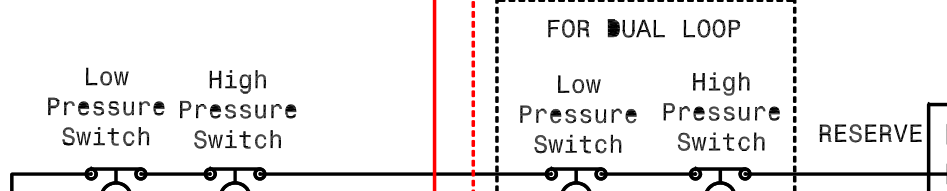
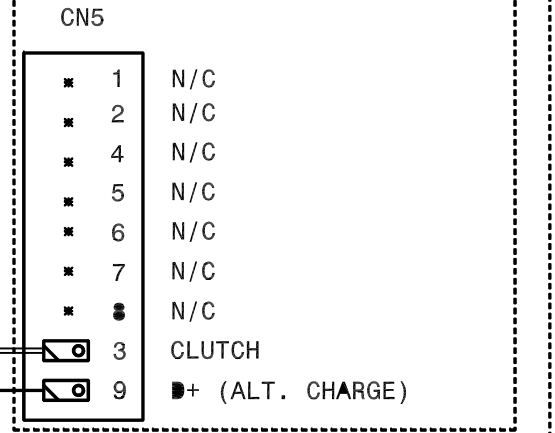
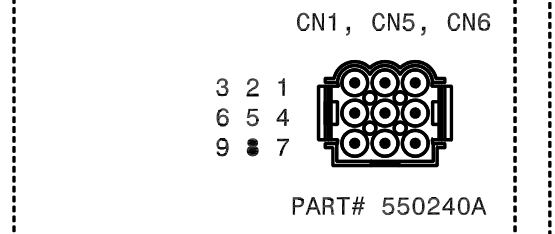
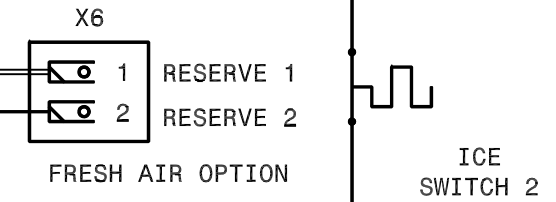
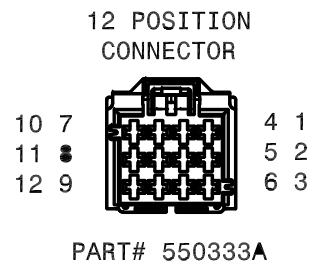
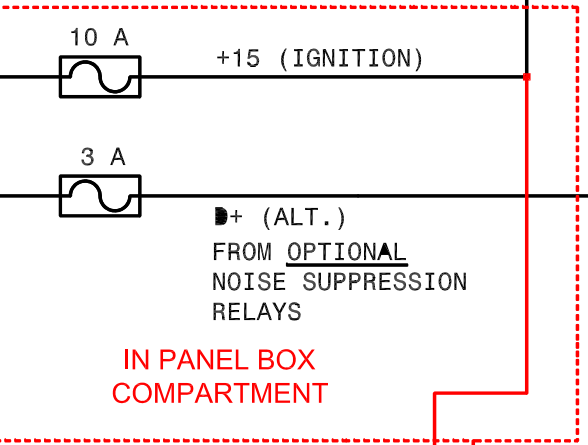
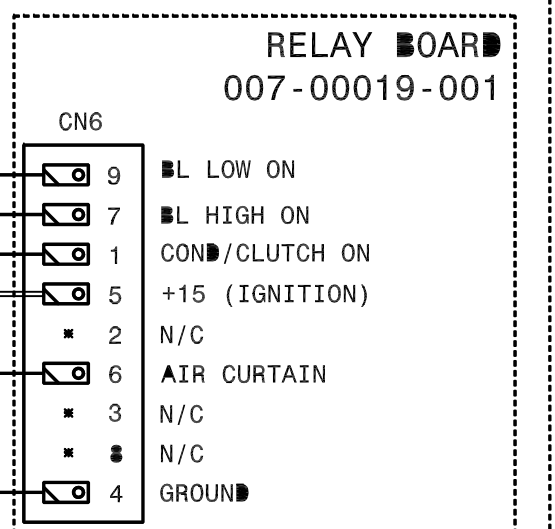
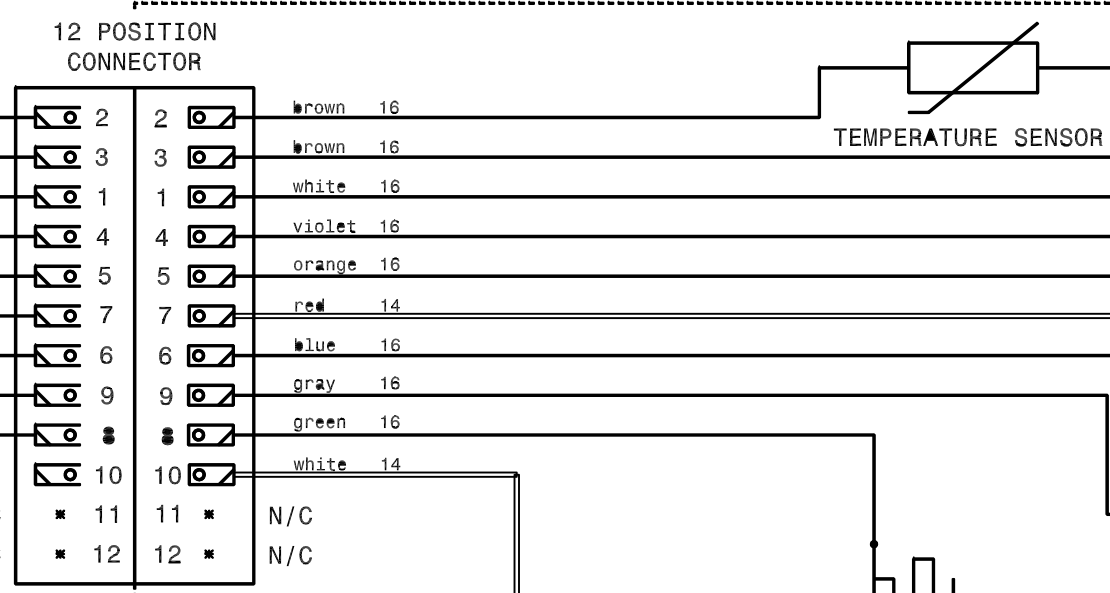
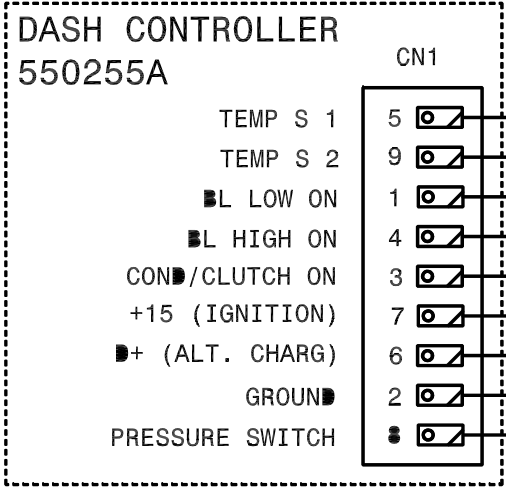
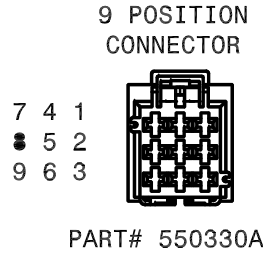

REF./POS. DIM		INFORMATION DIM		NOT SCALED DIM	
PERMISSIBLE DEVIATION FOR DIM WITHOUT TOLERANCES		VOLTAGE	WEIGHT	CAD SYSTEM	
ANSI				CATIA V5R19	
MATERIAL					
SURFACE PROTECTION					
PART NAME CC335 SL/DL 12V W/GLOBUS SL RELAY BOARD					
DATE 17/01/13	17/01/13	SCALE	DOC NO.	PART NO.	
NAME JOEYL	JIMW	FREE		20000001A-TA001	
RAW	CHECK	APP	STATUS		
		SIZE	ISO A2		
REPLACE BY PART-NO.		REPLACEMENT FOR PART-NO.		PAGE 1 / 1	

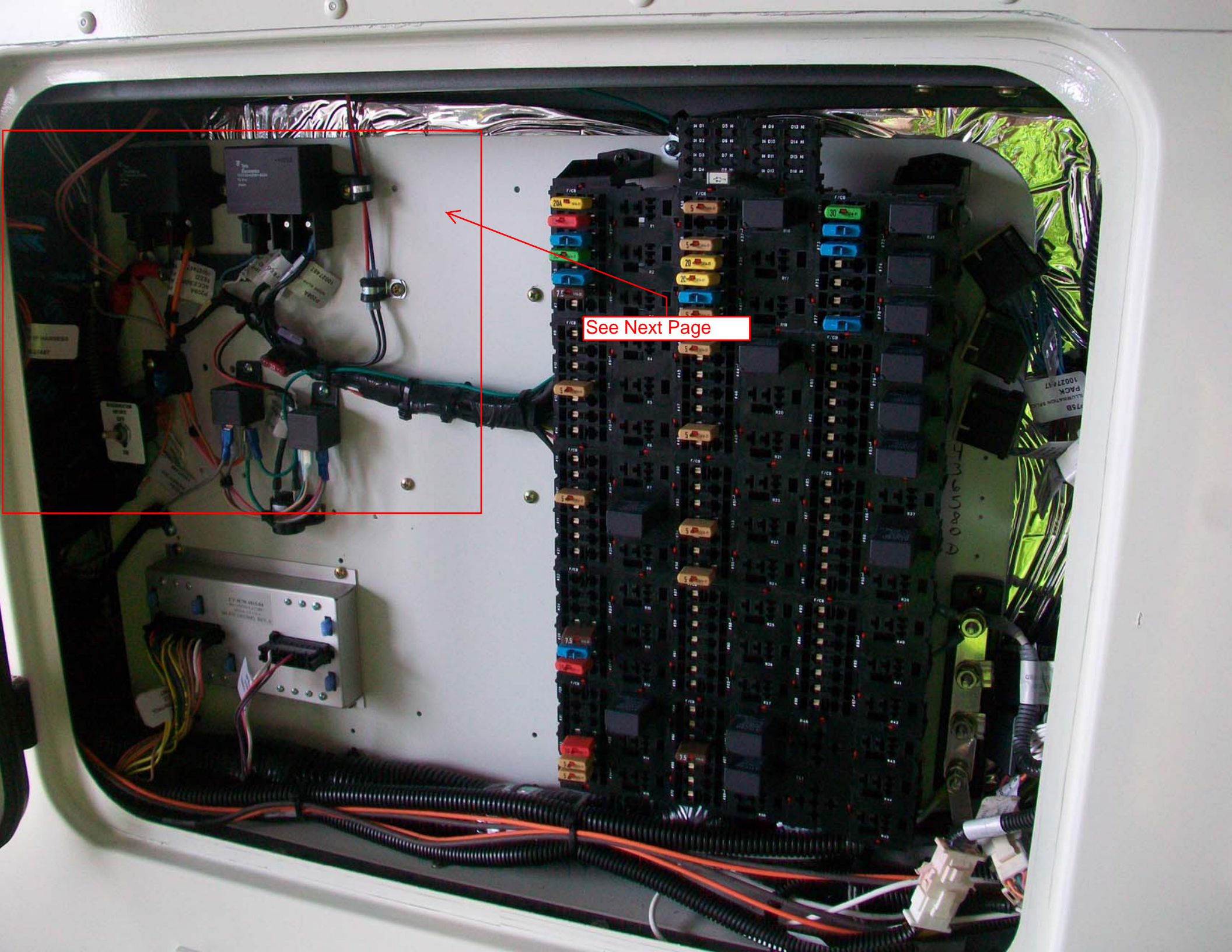

See Next Page

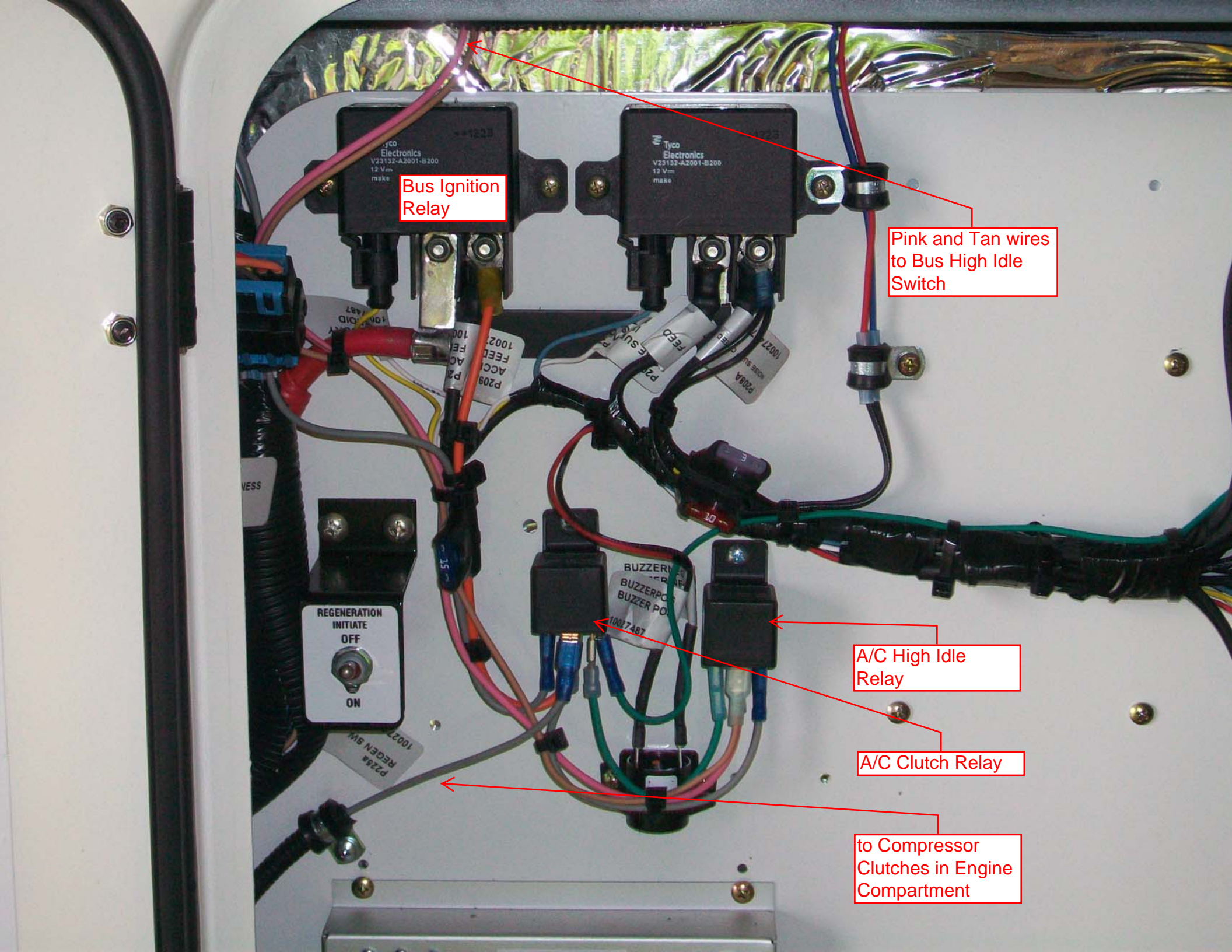

Bus Ignition Relay

Pink and Tan wires to Bus High Idle Switch

A/C High Idle Relay

A/C Clutch Relay

to Compressor Clutches in Engine Compartment

REGENERATION INITIATE OFF ON

BUZZER BUZZER BUZZER

P209 ACC FEED

P208A FEED

P208A FEED

P208A FEED

P214A REGEN SW

1007487

15

10