

Bill of Materials Listing

TransArctic Canada Inc.

3/18/2016
Page 1 of 1

Product Number	Description	Date	Weight	Uof M	Yield
Line Component Prod#	Description	Bin Unit	Qty		
KMC62693	Mt Kit, ISB 2016, HDX , 2 TM-21, '16		6/7/2013	16.17	0
10	BEL11753		Belt, A gr, 1753mm (69") (17690)	each	1
15	BEL82273		Belt, 8gr, 2273mm (89.5") (5080895)	each	1
20	BMC67022		Bkt, Upper, Weldmt, D/S, ISB, TM-21	each	1
30	BMC67023		Bkt, Lower, Weldmt, D/S, ISB, TM-21	each	1
40	BMC67141		Bkt, Main, Weldm't,Tensioner, HDX, '16	each	1
50	PNS04010		Pin, Spring, 1/4" d x 5/8" lg, ST, PLT	each	1
60	PUL10094		Pulley, Idler, SA,94d x 18w,Blk (IP-103)	each	1
70	PUL67001		Pulley, Crank, ADD-ON, Cum, ISB, 6.7, SA	each	1
80	SCD14010		Spacer, Col, Drl, 14mm x25.4o x10.32i	each	1
90	SLV17040		Sleeve, Pulley, 16.9o x 14.29mm x 10.08i	each	1
100	TEN00002		Tenr, Spring, C/W, 90d, 3/8 x4.5"/3.5"	each	1
110	KBC62693		Bag Kit, Fasteners, KMC62693	each	1

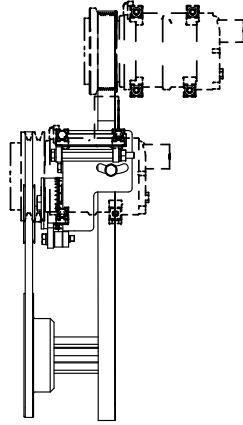
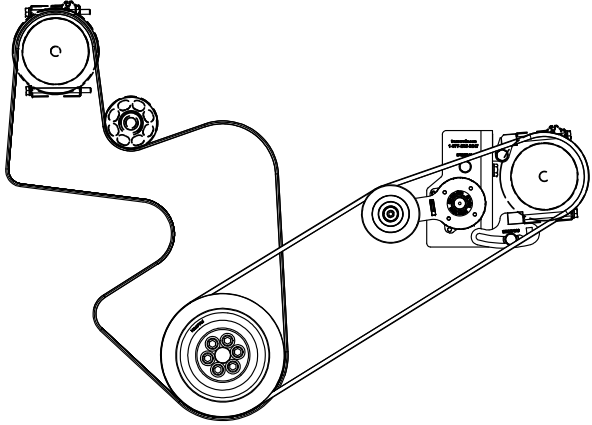
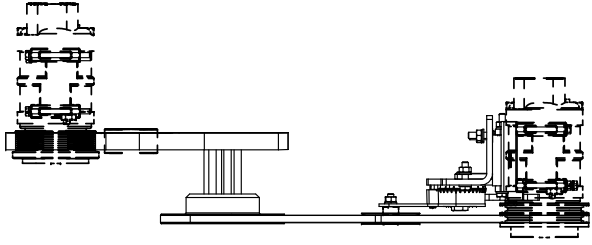



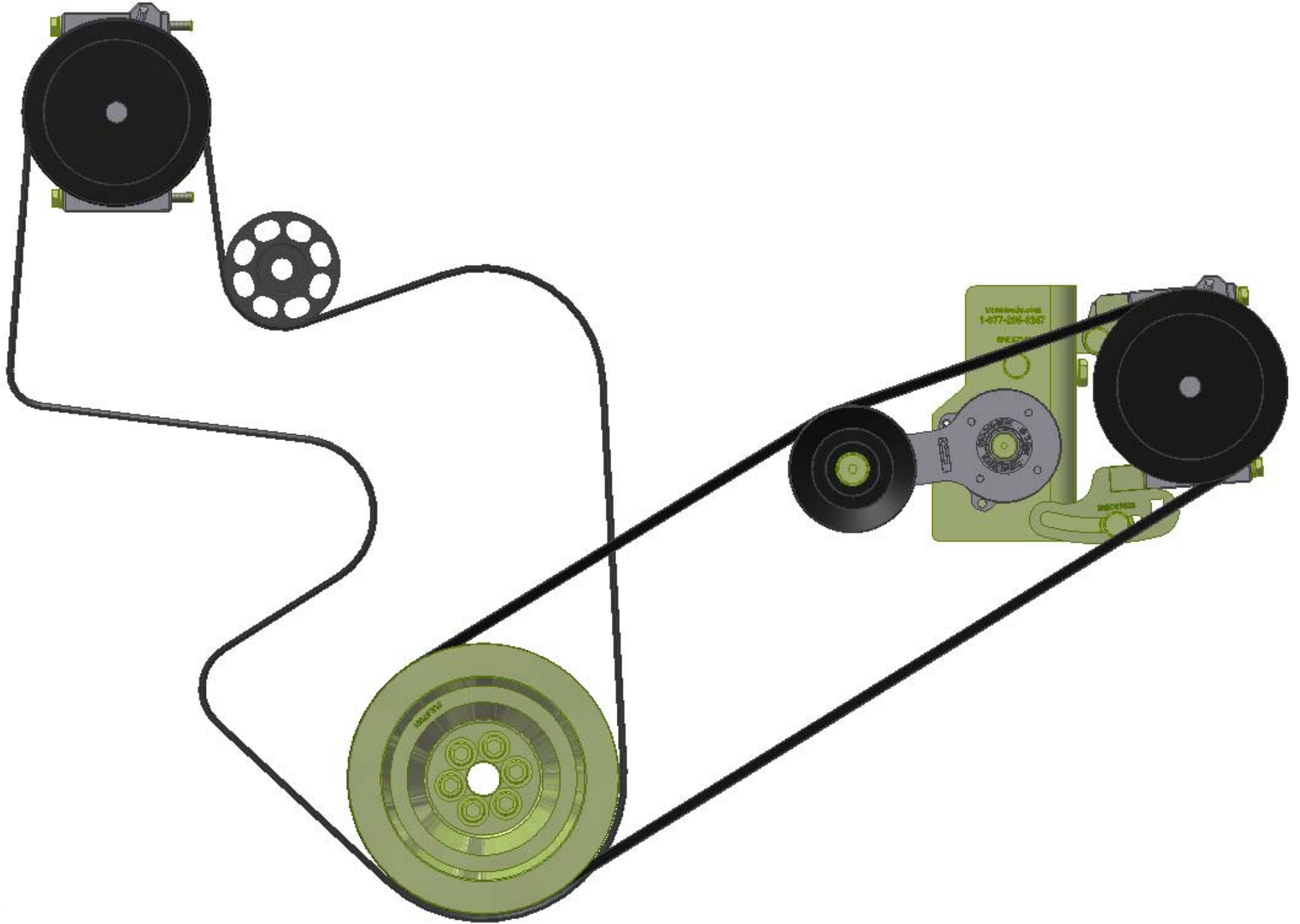

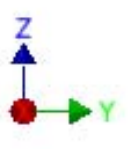
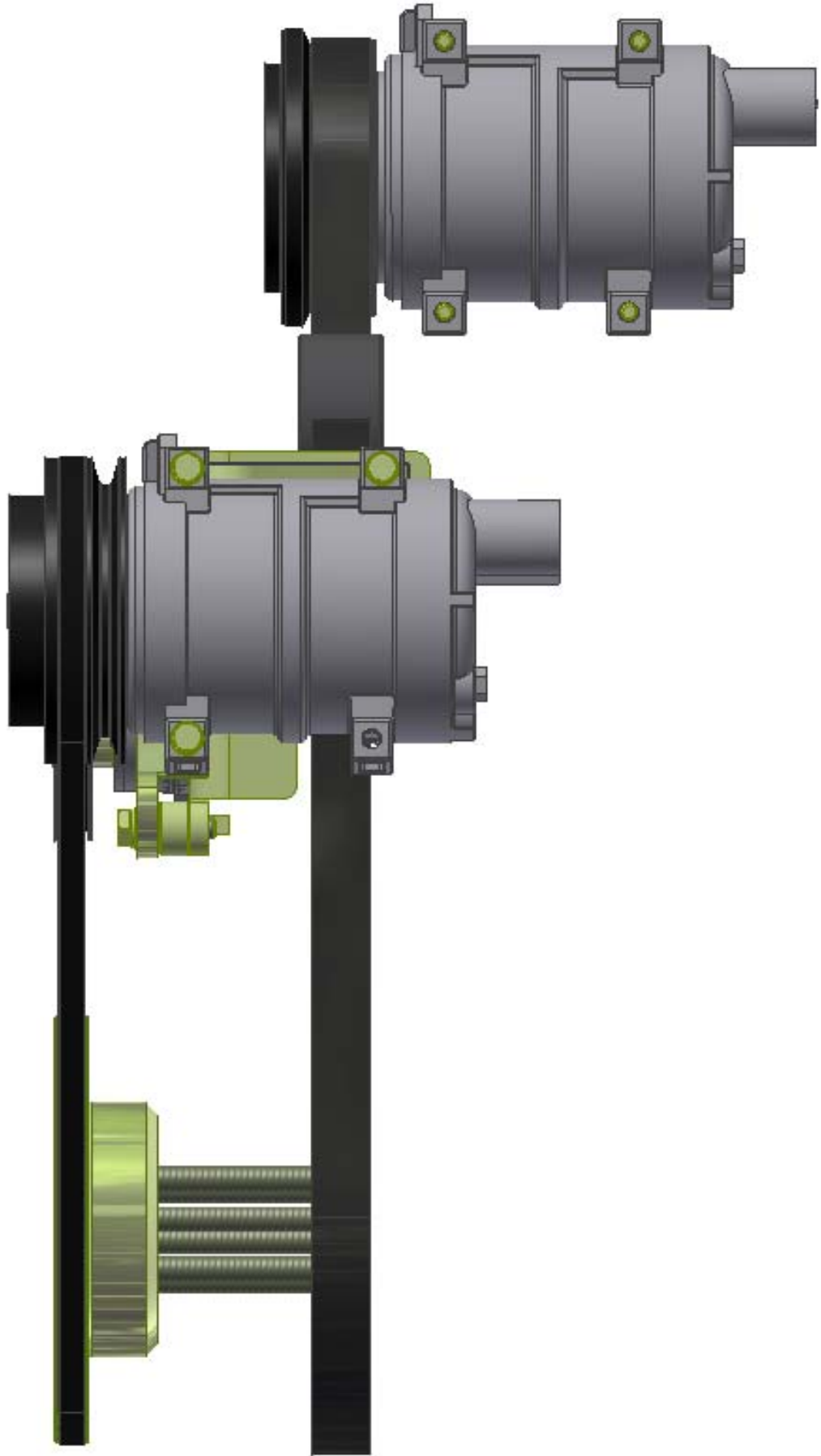

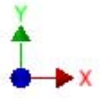
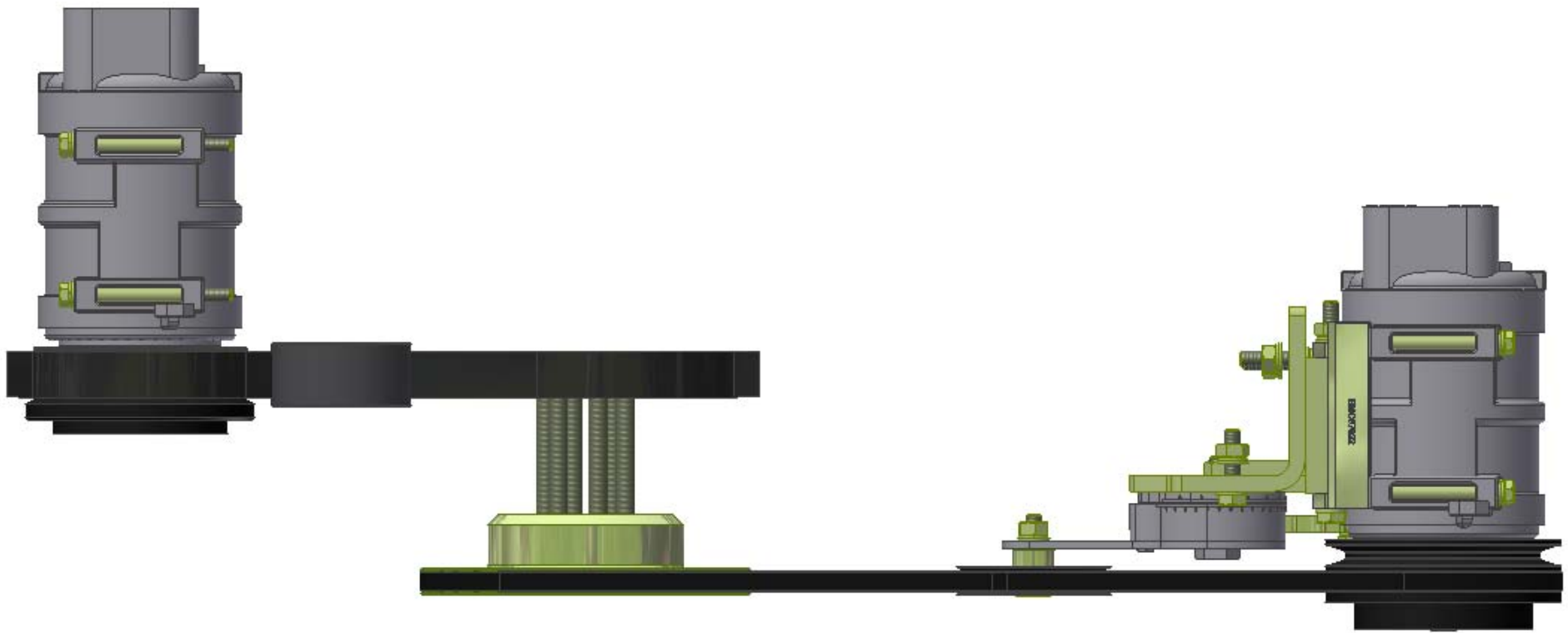

TransArctic A/C Compressor Mount Installation Disclaimer

All compressor mounts should be installed by qualified and trained personnel using proper tools and equipment in safe working conditions following industry standard guidelines for motor vehicle service and repair.

The installer of any compressor mount purchased from TransArctic must undertake all responsibility of issues arising from that compressor bracket being installed on any vehicle. As well as insure that a **proper and sufficient ground** is established between the compressors' clutches and the vehicle's engine. Mount functionality, operation and durability can all be compromised by an incompetent installation.

Due to the many different situations, parameters and application criteria, which are beyond the compressor mount manufacturer's control, TransArctic does not warrant design, durability, or operational functionality of any compressor mount improperly installed by another party.

With no implied guarantees it is the mount installer's strict responsibility to determine safety and functionality, of the compressor mount, at the time of installation.

Please contact TransArctic with any issue arising from installation so we may better improve the product. If you have any reservations about the compressor mount integrity contact TransArctic immediately at 1-877-COLD-AIR.

Mark OEM tensioner location

Install Kit

Check for Interferences

Check to ensure that the proper OEM tensioner orientation is maintained

Run engine with A/C system engaged for at least 10 minutes to run in belt

Check OEM tensioner orientation and adjust as required

Responsabilidad limitada de TransArctic en la instalación del soporte del compresor

Todos los soportes de los compresores deben ser instalados por personas calificadas y entrenadas, usando para ello los equipos y herramientas necesarios para esta labor en buenas condiciones y según las normas y guías para el servicio y/o reparación de motores de vehículos.

El instalador de los soportes comprados en TransArctic asume toda la responsabilidad de cualquier problema que surga en el soporte del compresor al vehículo; de igual manera es responsable que el cable a tierra sea conectado entre el embrague del compresor y el motor del vehículo.

Se advierte que el buen funcionamiento y la durabilidad del soporte pueden ser comprometidos por defectos en su instalación.

Debido a las diversas situaciones que se puedan presentar fuera del control del fabricante, TransArctic no garantiza el diseño, la durabilidad o el correcto funcionamiento de cualquier equipo inapropiadamente instalado por terceros.

Esta sobreentendido que el Instalador del montaje del compresor es estrictamente responsable de la seguridad y funcionamiento del equipo en el momento de la instalación.

Si tuviera algún problema o duda acerca de la instalación del soporte del compresor pongase en contacto inmediatamente con TransArctic al teléfono 1-877-COLD-AIR de modo que podamos mejorar nuestro producto.

Note la ubicación del medidor de tensión OEM

Instale el equipo

Controlar si hay interferencias.

Asegurese que el medidor de tensión mantenga la orientación justa.

Encienda el motor por lo menos 10 minutos con el sistema A/C enganchado para que la correa corra

Controle la orientación justa del medidor de tensión y ajuste a las condiciones requeridas del fabricante